



1x1 Coyote Frame Kit



MSRP	\$82.00
product code (curved)	COY-FK-1X1-C
product code (straight)	COY-FK-1X1-S
Trade Price (Hardware)	
Standard	Advanced
\$	\$67.00
Hardware Includes:	
<ul style="list-style-type: none"> • 01 x frame (1x1) • 10 x channel bars • 02 x front panel hanger • 02 x end cap panel hangers 	

2x1 Coyote Frame Kit



MSRP	\$118.00
product code (curved)	COY-FK-2X1-C
product code (straight)	COY-FK-2X1-S
Trade Price (Hardware)	
Standard	Advanced
\$	\$95.00
Hardware Includes:	
<ul style="list-style-type: none"> • 01 x frame (2x1) • 12 x channel bars • 03 x front panel hangers • 02 x end cap panel hangers 	

3x1 Coyote Frame Kit

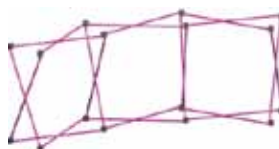

MSRP	\$146.00
product code (curved)	COY-FK-3X1-C
product code (straight)	COY-FK-3X1-S
Trade Price (Hardware)	
Standard	Advanced
\$	\$126.00
Hardware Includes:	
<ul style="list-style-type: none"> • 01 x frame (3x1) • 12 x channel bars • 01 x front panel hanger • 02 x end cap panel hangers 	

1/3 Height Fabric & Graphic Panel Options

Fabric Panels	Code	Size	Standard	Advanced
front curved	COY-FP-C-1	26.5" w x 30.625" h	\$	\$50.00
rear curved	COY-RFP-C-1	31.75" w x 30.625" h	\$	\$75.00
end cap	COY-FEC-1	23.5" w x 30.625" h	\$	\$50.00
straight	COY-FP-S-1	28.83" w x 30.625" h	\$	\$59.00
22mil UV printed Mural Panels	Code	Size	Standard	Advanced
front curved	COY-GCP-1	26.5" w x 30.625" h	\$	\$100.00
rear curved	COY-GCBP-1	31.75" w x 30.625" h	\$	\$117.00
end cap	COY-ECP-1	23.5" w x 30.625" h	\$	\$100.00
straight	COY-GSP-1	28.875" w x 30.625" h	\$	\$109.00

Options & Accessories

OCP Molded Case

oval molded popup case with fittings



product code	OCP
Standard	Advanced
\$	\$229.00

Graphic Hanger

hanging hardware for graphic panels



product code	
Standard	Advanced
\$	\$4.20

confirm size, curved, straight rear or end cap

Channel Bar (Spare)

single replacement/extra channel bars



product code	C-MB-1
Standard	Advanced
\$	\$5.85

uses "B" magnet

Coyote Monitor Mount

integrates monitor into a Coyote frame



product code	COY-LCD-MS
Standard	Advanced
\$	\$409.00

comes with monitor bracket

Internal Shelf Kit

internal shelf kit for a curved frame Coyote



product code	COY-SH-C
Standard	Advanced
\$	\$434.00
extra shelves \$42 each	
add internal lighting \$20	

1x1 Coyote Frame w/Fabric End Cap Kit



MSRP	\$190.00
product code (curved)	COY-EK-1X1-C
product code (straight)	COY-EK-1X1-S
Trade Price (Hardware)	
Standard	Advanced
\$	\$159.00
Hardware Includes:	
<ul style="list-style-type: none"> • 01 x frame (1x1) • 10 x channel bars • 02 x front panel hanger • 02 x fabric end cap panels 	

2x1 Coyote Frame w/Fabric End Cap Kit

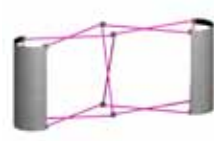

MSRP	\$229.00
product code (curved)	COY-EK-2X1-C
product code (straight)	COY-EK-2X1-S
Trade Price (Hardware)	
Standard	Advanced
\$	\$187.00
Hardware Includes:	
<ul style="list-style-type: none"> • 01 x frame (2x1) • 12 x channel bars • 03 x front panel hangers • 02 x fabric end cap panels 	

3x1 Coyote Frame w/Fabric End Cap Kit

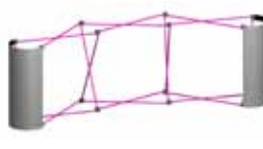

MSRP	\$255.00
product code (curved)	COY-EK-3X1-C
product code (straight)	COY-EK-3X1-S
Trade Price (Hardware)	
Standard	Advanced
\$	\$218.00
Hardware Includes:	
<ul style="list-style-type: none"> • 01 x frame (3x1) • 12 x channel bars • 01 x front panel hangers • 02 x fabric end cap panels 	

1x1 Coyote Full Fabric Kit



Curved Frame		Straight Frame	
MSRP	\$245.00	MSRP	\$253.00
code:	COY-K-1X1-C	code:	COY-K-1X1-S
Trade Price (Hardware)		Trade Price (Hardware)	
Standard	Advanced	Standard	Advanced
\$	\$205.00	\$	\$212.00
Hardware Includes:			
<ul style="list-style-type: none"> • 01 x frame (1x1) • 10 x channel bars • 01 x fabric front panel • 02 x end cap panel hangers 			

2x1 Coyote Full Fabric Kit



Curved Frame		Straight Frame	
MSRP	\$337.00	MSRP	\$354.00
code:	COY-K-2X1-C	code:	COY-K-2X1-S
Trade Price (Hardware)		Trade Price (Hardware)	
Standard	Advanced	Standard	Advanced
\$	\$279.00	\$	\$295.00
Hardware Includes:			
<ul style="list-style-type: none"> • 01 x frame (1x1) • 12 x channel bars • 02 x fabric front panel • 02 x end cap panel hangers 			

3x1 Coyote Full Fabric Kit

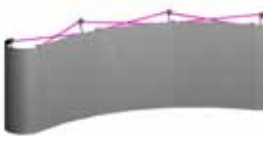

Curved Frame		Straight Frame	
MSRP	\$418.00	MSRP	\$444.00
code:	COY-K-3X1-C	code:	COY-K-3X1-S
Trade Price (Hardware)		Trade Price (Hardware)	
Standard	Advanced	Standard	Advanced
\$	\$355.00	\$	\$380.00
Hardware Includes:			
<ul style="list-style-type: none"> • 01 x frame (1x1) • 12 x channel bars • 03 x fabric front panel • 02 x end cap panel hangers 			



Coyote Expanding Display Systems

DISPLAYHQ.COM
423.952.0770
sales@DisplayHQ.com

Call/Email for current Discounts

2x2 Coyote Frame Kit

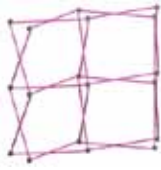

Curved Frame		Straight Frame	
MSRP	\$179.00	MSRP	\$179.00
code: COY-FK-2X2-C		code: COY-FK-2X2-S	
Trade Price (Hardware)		Trade Price (Hardware)	
Standard	Advanced	Standard	Advanced
\$	\$150.00	\$	\$150.00
Hardware Includes:			
<ul style="list-style-type: none"> • 01 x frame (2x2) • 10 x channel bars • 02 x front panel hangers • 02 x end cap panel hangers 			

3x2 Coyote Frame Kit



Curved Frame		Straight Frame	
MSRP	\$233.00	MSRP	\$233.00
code: COY-FK-3X2-C		code: COY-FK-3X2-S	
Trade Price (Hardware)		Trade Price (Hardware)	
Standard	Advanced	Standard	Advanced
\$	\$197.00	\$	\$197.00
Hardware Includes:			
<ul style="list-style-type: none"> • 01 x frame (3x2) • 12 x channel bars • 03 x front panel hangers • 02 x end cap panel hangers 			

1x3 Coyote Frame Kit



Curved Frame		Straight Frame	
MSRP	\$172.00	MSRP	\$172.00
code: COY-FK-1X3-C		code: COY-FK-1X3-S	
Trade Price (Hardware)		Trade Price (Hardware)	
Standard	Advanced	Standard	Advanced
\$	\$148.00	\$	\$148.00
Hardware Includes:			
<ul style="list-style-type: none"> • 01 x frame (3x1) • 12 x channel bars • 01 x front panel hanger • 02 x end cap panel hangers 			

2/3 Height Fabric & Graphic Panel Options

Fabric Panels	Code	Size	Standard	Advanced
front curved	COY-FP-C-2	26.5"W x 59.625"H	\$	\$67.00
rear curved	COY-RFP-C-2	31.75"W x 59.625"H	\$	\$92.00
end cap	COY-FEC-2	23.5"W x 59.625"H	\$	\$67.00
straight	COY-FP-S-2	28.83"W x 59.625"H	\$	\$75.00
22mil UV printed Mural Panels	Code	Size	Standard	Advanced
front curved	COY-GCP-2	26.5"W x 59.625"H	\$	\$167.00
rear curved	COY-GCBP-2	31.75"W x 59.625"H	\$	\$184.00
end cap	COY-ECP-2	23.5"W x 59.625"H	\$	\$167.00
straight	COY-GSP-2	28.875"W x 59.625"H	\$	\$175.00

Coyote Tower

Coyote Tower Frame Kit



MSRP	\$306.00
code	COY-3-TOW
Trade Price (Hardware)	
Standard	Advanced
\$	\$292.00
Hardware Includes:	
<ul style="list-style-type: none"> • 03 x frame (1x3) • 09 x channel bars • 06 x connectors • 03 x front panel hangers 	

2x2 Coyote Frame w/Fabric End Cap Kit



Curved Frame		Straight Frame	
MSRP	\$322.00	MSRP	\$322.00
code: COY-EK-2X2-C		code: COY-EK-2X2-S	
Trade Price (Hardware)		Trade Price (Hardware)	
Standard	Advanced	Standard	Advanced
\$	\$275.00	\$	\$275.00
Hardware Includes:			
<ul style="list-style-type: none"> • 01 x frame (2x2) • 10 x channel bars • 02 x front panel hangers • 02 x fabric end cap panels 			

3x2 Coyote Frame w/Fabric End Cap Kit

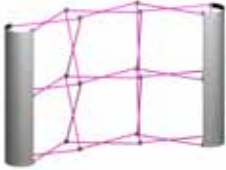

Curved Frame		Straight Frame	
MSRP	\$376.00	MSRP	\$376.00
code: COY-EK-3X2-C		code: COY-EK-3X2-S	
Trade Price (Hardware)		Trade Price (Hardware)	
Standard	Advanced	Standard	Advanced
\$	\$322.00	\$	\$322.00
Hardware Includes:			
<ul style="list-style-type: none"> • 01 x frame (3x2) • 12 x channel bars • 03 x front panel hangers • 02 x fabric end cap panels 			

1x3 Coyote Frame w/Fabric End Cap Kit



Curved Frame		Straight Frame	
MSRP	\$349.00	MSRP	\$349.00
code: COY-EK-1X3-C		code: COY-EK-1X3-S	
Trade Price (Hardware)		Trade Price (Hardware)	
Standard	Advanced	Standard	Advanced
\$	\$306.00	\$	\$306.00
Hardware Includes:			
<ul style="list-style-type: none"> • 01 x frame (1x3) • 12 x channel bars • 01 x front panel hanger • 02 x fabric end cap panels 			

Coyote Tower Full Fabric Kit



MSRP	\$587.00
code	COY-3-F-TOW
Trade Price (Hardware)	
Standard	Advanced
\$	\$542.00
Hardware Includes:	
<ul style="list-style-type: none"> • 03 x frame (1x3) • 09 x channel bars • 06 x connectors • 03 x curved fabric panels 	

2x2 Coyote Full Fabric Kit



Curved Frame		Straight Frame	
MSRP	\$464.00	MSRP	\$480.00
code: COY-K-2X2-C		code: COY-K-2X2-S	
Trade Price (Hardware)		Trade Price (Hardware)	
Standard	Advanced	Standard	Advanced
\$	\$400.00	\$	\$417.00
Hardware Includes:			
<ul style="list-style-type: none"> • 01 x frame (2x2) • 10 x channel bars • 02 x fabric front panel • 02 x fabric end cap panels 			

3x2 Coyote Full Fabric Kit



Curved Frame		Straight Frame	
MSRP	\$590.00	MSRP	\$615.00
code: COY-K-3X2-C		code: COY-K-3X2-S	
Trade Price (Hardware)		Trade Price (Hardware)	
Standard	Advanced	Standard	Advanced
\$	\$510.00	\$	\$535.00
Hardware Includes:			
<ul style="list-style-type: none"> • 01 x frame (3x2) • 12 x channel bars • 03 x fabric front panels • 02 x fabric end cap panels 			

1x3 Coyote Full Fabric Kit



Curved Frame		Straight Frame	
MSRP	\$437.00	MSRP	\$445.00
code: COY-K-1X3-C		code: COY-K-1X3-S	
Trade Price (Hardware)		Trade Price (Hardware)	
Standard	Advanced	Standard	Advanced
\$	\$385.00	\$	\$394.00
Hardware Includes:			
<ul style="list-style-type: none"> • 01 x frame (1x3) • 12 x channel bars • 01 x fabric front panel • 02 x fabric end cap panels 			

Coyote Tower Full Graphic Kit



MSRP	\$1097.00
product code	COY-3-G-TOW
Trade Price (Hardware)	
Standard	Advanced
\$	\$992.00
add an OCS case	
\$	\$154.00
Hardware Includes:	
<ul style="list-style-type: none"> • 03 x frame (1x3) • 09 x channel bars • 06 x connectors • 03 x curved graphic panels 	



2x3 Coyote Frame Kit



Curved Frame		Straight Frame	
MSRP	\$246.00	MSRP	\$246.00
code: COY-FK-2X3-C		code: COY-FK-2X3-S	
Trade Price (Hardware)		Trade Price (Hardware)	
Standard	Advanced	Standard	Advanced
\$	\$208.00	\$	\$208.00
Hardware Includes:			
<ul style="list-style-type: none"> • 01 x frame (2x3) • 15 x channel bars • 02 x front panel hangers • 02 x end cap panel hangers 			

3x3 Coyote Frame Kit



Curved Frame		Straight Frame	
MSRP	\$357.00	MSRP	\$357.00
code: COY-FK-3X3-C		code: COY-FK-3X3-S	
Trade Price (Hardware)		Trade Price (Hardware)	
Standard	Advanced	Standard	Advanced
\$	\$320.00	\$	\$320.00
Hardware Includes:			
<ul style="list-style-type: none"> • 01 x frame (3x3) • 18 x channel bars • 03 x front panel hangers • 02 x end cap panel hangers 			

4x3 Coyote Frame Kit

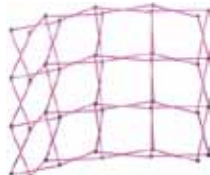

Curved Frame		Straight Frame	
MSRP	\$399.00	MSRP	\$399.00
code: COY-FK-4X3-C		code: COY-FK-4X3-S	
Trade Price (Hardware)		Trade Price (Hardware)	
Standard	Advanced	Standard	Advanced
\$	\$355.00	\$	\$355.00
Hardware Includes:			
<ul style="list-style-type: none"> • 01 x frame (4x3) • 18 x channel bars • 04 x front panel hangers • 02 x end cap panel hangers 			

Full Height Fabric & Graphic Panel Options

Fabric Panels	Code	Size	Standard	Advanced
front curved	COY-FP-C	26.5" w x 87.562" h	\$	\$84.00
rear curved	COY-RFP-C	31.75" w x 87.562" h	\$	\$108.00
end cap	COY-FEC	23.5" w x 87.562" h	\$	\$84.00
straight	COY-FP-S	28.83" w x 87.562" h	\$	\$917.00
22mil UV printed Mural Panels	Code	Size	Standard	Advanced
front curved	COY-GCP	26.5" w x 87.562" h	\$	\$233.00
rear curved	COY-GCBP	31.75" w x 87.562" h	\$	\$250.00
end cap	COY-ECP	23.5" w x 87.562" h	\$	\$233.00
straight	COY-GSP	28.83" w x 87.562" h	\$	\$250.00

Options & Accessories

OCP Molded Case

oval molded popup case with fittings



product code	OCP
Standard	Advanced
\$	\$228.00

Graphic Hanger

hanging hardware for graphic panels



product code	
Standard	Advanced
\$	\$4.17

confirm size, curved, straight rear or end cap

Channel Bar (Spare)

single replacement/extra channel bars



product code	C-MB-1
Standard	Advanced
\$	\$5.83

uses "B" magnet

2x3 Coyote Frame w/Fabric End Cap Kit



Curved Frame		Straight Frame	
MSRP	\$424.00	MSRP	\$424.00
code: COY-EK-2X3-C		code: COY-EK-2X3-S	
Trade Price (Hardware)		Trade Price (Hardware)	
Standard	Advanced	Standard	Advanced
\$	\$367.00	\$	\$367.00
Hardware Includes:			
<ul style="list-style-type: none"> • 01 x frame (2x3) • 15 x channel bars • 02 x front panel hangers • 02 x fabric end cap panels 			

3x3 Coyote Frame w/Fabric End Cap Kit



Curved Frame		Straight Frame	
MSRP	\$534.00	MSRP	\$534.00
code: COY-EK-3X3-C		code: COY-EK-3X3-S	
Trade Price (Hardware)		Trade Price (Hardware)	
Standard	Advanced	Standard	Advanced
\$	\$478.00	\$	\$478.00
Hardware Includes:			
<ul style="list-style-type: none"> • 01 x frame (3x3) • 18 x channel bars • 03 x front panel hangers • 02 x fabric end cap panels 			

4x3 Coyote Frame w/Fabric End Cap Kit



Curved Frame		Straight Frame	
MSRP	\$575.00	MSRP	\$575.00
code: COY-EK-4X3-C		code: COY-EK-4X3-S	
Trade Price (Hardware)		Trade Price (Hardware)	
Standard	Advanced	Standard	Advanced
\$	\$513.00	\$	\$513.00
Hardware Includes:			
<ul style="list-style-type: none"> • 01 x frame (4x3) • 21 x channel bars • 04 x front panel hangers • 02 x fabric end cap panels 			

Coyote Bubble Panel

Bubble Panel - Fabric

bubble panel kit includes panel and all hardware

MSRP	\$155.00
product code	COY-FBBP
Standard	Advanced
\$	\$134.00

Bubble Panel - Graphic

bubble panel kit includes panel and all hardware

MSRP	\$408.00
product code	COY-GBBP-O
Standard	Advanced
\$	\$292.00

Bubble Panel Back Lighting Kit

lighting kit includes 02 x T4, 36" strip lights with fittings, hardware only

MSRP	\$442.00
product code	COY-BBL-LT
Standard	Advanced
\$	\$400.00

Bubble Panel Back Lit

back lit bubble panel, full height w/translucent graphic

MSRP	\$475.00
product code	COY-GBBP-T
Standard	Advanced
\$	\$308.00

2x3 Coyote Full Fabric Kit



Curved Frame		Straight Frame	
MSRP	\$598.00	MSRP	\$615.00
code: COY-K-2X3-C		code: COY-K-2X3-S	
Trade Price (Hardware)		Trade Price (Hardware)	
Standard	Advanced	Standard	Advanced
\$	\$525.00	\$	\$542.00
Hardware Includes:			
<ul style="list-style-type: none"> • 01 x frame (2x3) • 15 x channel bars • 02 x fabric front panels • 02 x fabric end cap panels 			

3x3 Coyote Full Fabric Kit



Curved Frame		Straight Frame	
MSRP	\$799.00	MSRP	\$825.00
code: COY-K-3X3-C		code: COY-K-3X3-S	
Trade Price (Hardware)		Trade Price (Hardware)	
Standard	Advanced	Standard	Advanced
\$	\$715.00	\$	\$740.00
Hardware Includes:			
<ul style="list-style-type: none"> • 01 x frame (3x3) • 18 x channel bars • 03 x fabric front panels • 02 x fabric end cap panels 			

4x3 Coyote Full Fabric Kit



Curved Frame		Straight Frame	
MSRP	\$925.00	MSRP	\$960.00
code: COY-K-4X3-C		code: COY-K-4X3-S	
Trade Price (Hardware)		Trade Price (Hardware)	
Standard	Advanced	Standard	Advanced
\$	\$830.00	\$	\$864.00
Hardware Includes:			
<ul style="list-style-type: none"> • 01 x frame (4x3) • 21 x channel bars • 04 x fabric front panels • 02 x fabric end cap panels 			

America's Favorite Tradeshow Supplier

Coyote Expanding Display Systems

DISPLAYHQ.COM
423.952.0770
sales@DisplayHQ.com

Call/Email for current Discounts

3x3 Coyote Frame with Fabric Encaps Fast Kit



Curved Frame		Straight Frame	
MSRP	\$918.00	MSRP	\$918.00
COY-KK-3X3-C		COY-KK-3X3-S	
Trade Price		Trade Price	
Standard	Advanced	Standard	Advanced
\$	\$824.00	\$	\$824.00

Hardware Includes:

- 01 x frame (3x3)
- 18 x channel bars
- 03 x front panel hanger
- 02 x fabric end cap panels
- 02 x Lumina 200 floodlights
- 01 x OCP molded case

4x3 Coyote Frame with Fabric Encaps Fast Kit

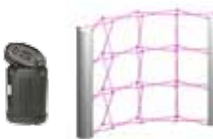

Curved Frame		Straight Frame	
MSRP	\$952.00	MSRP	\$952.00
COY-KK-4X3-C		COY-KK-4X3-S	
Trade Price		Trade Price	
Standard	Advanced	Standard	Advanced
\$	\$855.00	\$	\$855.00

Hardware Includes:

- 01 x frame (4x3)
- 21 x channel bars
- 04 x front panel hanger
- 02 x fabric end cap panels
- 02 x Lumina 200 floodlights
- 01 x OCP molded case

Horseshoe Coyote Frame Fast Kit



MSRP	\$1,364.00
product code	COY-KK-HS
Trade Price (Hardware)	
Standard	Advanced
\$	\$1215.00

Hardware Includes:

- 01 x straight frame (3x3)
- 02 straight frames (1x3)
- 36 x channel bars
- 07 x straight front panel hangers
- 02 x end cap panel hangers
- 02 ghost connector hangers
- 03 x Lumina 200 floodlights
- 02 x OCP molded cases

Horseshoe Deluxe Coyote Frame Fast Kit



MSRP	\$1,580.00
product code	COY-KK-DHS
Trade Price (Hardware)	
Standard	Advanced
\$	\$1405.00

Hardware Includes:

- 01 x straight frame (3x3)
- 04 straight frames (1x3)
- 42 x channel bars
- 07 x straight front panel hangers
- 02 x end cap panel hangers
- 04 x linking panel hangers
- 03 x Lumina 200 floodlights
- 02 x OCP molded cases

Gullwing Coyote Frame Fast Kit

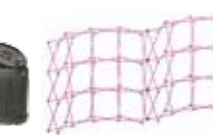

MSRP	\$1,522.00
product code	COY-KK-GW
Trade Price (Hardware)	
Standard	Advanced
\$	\$1367.00

Hardware Includes:

- 02 x curved frame (4x3)
- 36 x channel bars
- 08 x front curved panel hangers
- 02 x end cap panel hangers
- 01 x linking panel hanger
- 04 x Lumina 200 floodlights
- 02 x OCP molded cases

3x3 Coyote Full Fabric Panel Fast Kit



Curved Frame		Straight Frame	
MSRP	\$1199.00	MSRP	\$1224.00
COY-KKF-3X3-C		COY-KKF-3X3-S	
Trade Price		Trade Price	
Standard	Advanced	Standard	Advanced
\$	\$1072.00	\$	\$1097.00

Hardware Includes:

- 01 x frame (3x3)
- 18 x channel bars
- 03 x fabric front panels
- 02 x fabric end cap panels
- 02 x Lumina 200 floodlights
- 01 x OCP molded case

4x3 Coyote Full Fabric Panel Fast Kit



Curved Frame		Straight Frame	
MSRP	\$1312.00	MSRP	\$1345.00
COY-KKF-4X3-C		COY-KKF-4X3-S	
Trade Price		Trade Price	
Standard	Advanced	Standard	Advanced
\$	\$1175.00	\$	\$1175.00

Hardware Includes:

- 01 x frame (4x3)
- 21 x channel bars
- 04 x fabric front panels
- 02 x fabric end cap panels
- 02 x Lumina 200 floodlights
- 01 x OCP molded case

Horseshoe Coyote Full Fabric Panel Fast Kit



MSRP	\$2,430.00
product code	COY-KKF-HS
Trade Price (Hardware)	
Standard	Advanced
\$	\$2178.00

Hardware Includes:

- 01 x straight frame (3x3)
- 02 straight frames (1x3)
- 36 x channel bars
- 07 x straight front fabric panels
- 02 x fabric end cap panels
- 02 ghost fabric panels
- 03 x Lumina 200 floodlights
- 02 x OCP molded cases

Horseshoe Deluxe Coyote Full Fabric Panel Fast Kit



MSRP	\$2,856.00
product code	COY-KKF-DHS
Trade Price (Hardware)	
Standard	Advanced
\$	\$2558.00

Hardware Includes:

- 01 x straight frame (3x3)
- 04 straight frames (1x3)
- 42 x channel bars
- 07 x straight front fabric panels
- 02 x fabric end cap panels
- 04 x linking fabric panels
- 03 x Lumina 200 floodlights
- 02 x OCP molded cases

Gullwing Coyote Full Fabric Panel Fast Kit

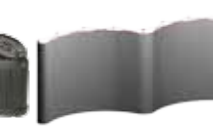

MSRP	\$2,510.00
product code	COY-KKF-GW
Trade Price (Hardware)	
Standard	Advanced
\$	\$2253.00

Hardware Includes:

- 02 x curved frame (4x3)
- 36 x channel bars
- 08 x front curved fabric panels
- 02 x fabric end cap panels
- 01 x linking fabric panel
- 04 x Lumina 200 floodlights
- 02 x OCP molded cases

3x3 Coyote Full Graphic Mural Fast Kit



Curved Frame		Straight Frame	
MSRP	\$2033.00	MSRP	\$2085.00
COY-KKG-3X3-C		COY-KKG-3X3-S	
Trade Price		Trade Price	
Standard	Advanced	Standard	Advanced
\$	\$1810.00	\$	\$1860.00

Hardware Includes:

- 01 x frame (3x3)
- 18 x channel bars
- 03 x front graphic mural panels
- 02 x graphic end cap panels
- 02 x Lumina 200 floodlights
- 01 x OCP molded case

4x3 Coyote Full Graphic Mural Fast Kit



Curved Frame		Straight Frame	
MSRP	\$2330.00	MSRP	\$2399.00
COY-KKG-4X3-C		COY-KKG-4X3-S	
Trade Price		Trade Price	
Standard	Advanced	Standard	Advanced
\$	\$2075.00	\$	\$2142.00

Hardware Includes:

- 01 x frame (4x3)
- 21 x channel bars
- 04 x front graphic mural panels
- 02 x graphic end cap panels
- 02 x Lumina 200 floodlights
- 01 x OCP molded case

Horseshoe Coyote Full Graphic Mural Fast Kit



MSRP	\$4,359.00
product code	COY-KKG-HS
Trade Price (Hardware)	
Standard	Advanced
\$	\$3887.00

Hardware Includes:

- 01 x straight frame (3x3)
- 02 straight frames (1x3)
- 36 x channel bars
- 07 x straight front graphic panels
- 02 x graphic end cap panels
- 02 ghost graphic panels
- 03 x Lumina 200 floodlights
- 02 x OCP molded cases

Horseshoe Deluxe Coyote Full Graphic Mural Fast Kit



MSRP	\$5,125.00
product code	COY-KKG-DHS
Trade Price (Hardware)	
Standard	Advanced
\$	\$4567.00

Hardware Includes:

- 01 x straight frame (3x3)
- 04 straight frames (1x3)
- 42 x channel bars
- 07 x straight front graphic panels
- 02 x graphic end cap panels
- 04 x linking graphic panels
- 03 x Lumina 200 floodlights
- 02 x OCP molded cases

Gullwing Coyote Full Graphic Mural Fast Kit



MSRP	\$4,380.00
product code	COY-KKG-GW
Trade Price (Hardware)	
Standard	Advanced
\$	\$3903.00

Hardware Includes:

- 02 x curved frame (4x3)
- 36 x channel bars
- 08 x front curved graphic panels
- 02 x graphic end cap panels
- 01 x linking graphic panel
- 04 x Lumina 200 floodlights
- 02 x OCP molded cases

8' Serpentine Coyote Frame Kit



MSRP	\$772.00
product code	COY-KK-ST-8
Trade Price (Hardware)	
Standard	Advanced
\$	\$690.00
Hardware Includes:	
<ul style="list-style-type: none"> • 01 x 8' Serpentine frame • 18 x channel bars • 01 outer/rear curved hanger • 02 x front curved hangers • 02 x end cap hangers • 02 x Lumina 200 floodlights • 01 x OCP molded case 	

10' Serpentine Coyote Frame Kit



MSRP	\$810.00
product code	COY-KK-ST-10
Trade Price (Hardware)	
Standard	Advanced
\$	\$725.00
Hardware Includes:	
<ul style="list-style-type: none"> • 01 x 10' Serpentine frame • 21 x channel bars • 02 outer/rear curved hangers • 02 x front curved hangers • 02 x end cap hangers • 02 x Lumina 200 floodlights • 01 x OCP molded case 	

20' Serpentine Coyote Frame Kit



MSRP	\$1,480.00
product code	COY-KK-SPNT
Trade Price (Hardware)	
Standard	Advanced
\$	\$1330.00
Hardware Includes:	
<ul style="list-style-type: none"> • 01 x curved frame (4x3) • 01 curved frame (3x3) • 33 x channel bars • 04 x front curved panel hangers • 03 x rear curved panel hangers • 01 x linking panel hanger • 02 x end cap panel hangers • 04 x Lumina 200 floodlights • 02 x OCP molded cases 	

Case to Counter Conversion Graphic

printed graphic wraps around OCP

product code	OCP-C2C-G
Standard	Advanced
\$	\$184.00



graphic size = 65.25" w x 30.25" h

Case to Counter Conversion Fabric

fabric panel wraps around OCP

product code	OCP-C2C
Standard	Advanced
\$	\$59.00



panel size = 69" w x 30.25" h

Channel Bar (Spare)

single replacement/extra channel bars

product code	C-MB-1
Standard	Advanced
\$	\$5.85



uses "B" magnet

8' Serpentine Coyote Full Fabric Panel Kit



MSRP	\$1,240.00
product code	COY-KKF-ST-8
Trade Price (Hardware)	
Standard	Advanced
\$	\$1112.00
Hardware Includes:	
<ul style="list-style-type: none"> • 01 x 8' Serpentine frame • 18 x channel bars • 01 outer/rear curved fabric panel • 02 x front curved fabric panels • 02 x fabric end cap panels • 02 x Lumina 200 floodlights • 01 x OCP molded case 	

10' Serpentine Coyote Full Fabric Panel Kit



MSRP	\$1,392.00
product code	COY-KKF-ST-10
Trade Price (Hardware)	
Standard	Advanced
\$	\$1250.00
Hardware Includes:	
<ul style="list-style-type: none"> • 01 x 10' Serpentine frame • 21 x channel bars • 02 outer/rear curved fabric panels • 02 x front curved fabric panels • 02 x fabric end cap panels • 02 x Lumina 200 floodlights • 01 x OCP molded case 	

20' Serpentine Coyote Full Fabric Panel Kit



MSRP	\$2,458.00
product code	COY-KKF-SPNT
Trade Price (Hardware)	
Standard	Advanced
\$	\$2214.00
Hardware Includes:	
<ul style="list-style-type: none"> • 01 x curved frame (4x3) • 01 curved frame (3x3) • 33 x channel bars • 04 x front curved fabric panels • 03 x rear curved fabric panels • 01 x linking fabric panel • 02 x fabric end cap panels • 04 x Lumina 200 floodlights • 02 x OCP molded cases 	

Internal Shelf Kit

internal shelf kit for a curved frame Coyote

product code	COY-SH-C
Standard	Advanced
\$	\$434.00
extra shelves \$42 each	
add internal lighting \$20	



Internal Shelf Kit Carry Bag

carry bag with handles for internal shelf kit

product code	HZ-M-BG
Standard	Advanced
\$	\$75.00



8' Serpentine Coyote Full Graphic Mural Kit



MSRP	\$2,080.00
product code	COY-KKG-ST-8
Trade Price (Hardware)	
Standard	Advanced
\$	\$1854.00
Hardware Includes:	
<ul style="list-style-type: none"> • 01 x 8' Serpentine frame • 18 x channel bars • 01 outer/rear curved graphic panel • 02 x front curved graphic panels • 02 x graphic end cap panels • 02 x Lumina 200 floodlights • 01 x OCP molded case 	

10' Serpentine Coyote Full Graphic Mural Kit



MSRP	\$2,395.00
product code	COY-KKG-ST-10
Trade Price (Hardware)	
Standard	Advanced
\$	\$2134.00
Hardware Includes:	
<ul style="list-style-type: none"> • 01 x 10' Serpentine frame • 21 x channel bars • 02 outer/rear curved graphic panels • 02 x front curved graphic panels • 02 x graphic end cap panels • 02 x Lumina 200 floodlights • 01 x OCP molded case 	

20' Serpentine Coyote Full Graphic Mural Kit



MSRP	\$4135.00
product code	COY-KKG-SPNT
Trade Price (Hardware)	
Standard	Advanced
\$	\$3688.00
Hardware Includes:	
<ul style="list-style-type: none"> • 01 x curved frame (4x3) • 01 curved frame (3x3) • 33 x channel bars • 04 x front curved graphic panels • 03 x rear curved graphic panels • 01 x linking graphic panel • 02 x graphic end cap panels • 04 x Lumina 200 floodlights • 02 x OCP molded cases 	

Coyote Bubble Panel

Bubble Panel - Fabric

bubble panel kit includes panel and all hardware

MSRP	\$155.00
product code	COY-FBBP
Standard	Advanced
\$	\$134.00

Bubble Panel - Graphic

bubble panel kit includes panel and all hardware

MSRP	\$408.00
product code	COY-GBBP-O
Standard	Advanced
\$	\$292.00

Bubble Panel Back Lighting Kit

lighting kit includes 02 x T4, 36" strip lights with fittings, hardware only

MSRP	\$442.00
product code	COY-BBL-LT
Standard	Advanced
\$	\$400.00

Bubble Panel Back Lit

back lit bubble panel, full height w/translucent graphic

MSRP	\$475.00
product code	COY-GBBP-T
Standard	Advanced
\$	\$309.00