

# Display Planner & Price Guide



# Display Your Best.™

**EXPOGO!**™

ExpoStar® Prezenta® ArchiForm®

November 2008

# CONTENTS

- 3 PANELS**  
Panel Specifications  
Palladian Stripes  
Standard Panel Sizes
- 4 TABLETOP DISPLAYS**
- 6 10' FREESTANDING DISPLAYS**
- 8 20' FREESTANDING DISPLAYS**
- 10 CUSTOM DISPLAYS**
- 12 NEXTDAY DISPLAYS**
- 13 ARCHIFORM SIGN SYSTEM**
- 14 SHOWMAX SELF-PACKING DISPLAY**
- 15 SHOWSTYLE BRIEFCASE PRESENTATION SYSTEM**
- 16 MAGICPAK AND BANNER STAND DISPLAY SYSTEMS**
- 17 PACTIVA COMPACT TABLETOP DISPLAY**
- 18 SMARTPAK IQ MOLDED SHIPPING CASES**
- 19 SHIPPING CASES, LIGHTS, FABRICS, PANEL ACCESSORIES**
- 20 PODIUMS, COUNTERS, HEADERS**
- 21 CUSTOMIZED COMPONENTS,**  
Tower and Bridge  
Soffit Panels  
Light Boxes  
Curve Panels  
Panel Window
- 21 TABLE ACCESSORIES, LITERATURE HOLDERS, SLATWALL, SHELVES**
- 22 GRAPHICS**  
Megamural  
Large Format Printing  
Strip Signs  
Header Graphics
- 23 GRAPHICS SPECIFICATIONS**

## ABOUT EXPOSTAR DISPLAYS

Hardly a trade show opens these days without evidence of the innovation and excellence of ExpoStar Displays somewhere on the show floor.

From the distinctive elegance of our trademarked arch-top folding displays to the compelling presence of our unique patented column design, ExpoStar's powerful portables provide display solutions to trade show challenges for clients large and small all across America.

When it comes to powerful portable displays that stop people in their tracks on the trade show floor, there's only one ExpoStar.

### Large Format Color Graphics

ExpoStar offers a full service graphics department with a staff of talented designers to help in all phases of planning and designing your display. Using state-of-the-art graphic computers and large format color printers we can work with existing artwork or create spectacular murals from your slides, prints or artwork.

### Shipping Information

Our production time is one of the fastest in the industry and your shipment is monitored every step of the way with our UPS Maxitrac and FedEx Ship Manager ground computer terminals. Most display orders ship 10 working days from the receipt of order with a 50% deposit. For complex graphics please allow 3 weeks to avoid rushing the design process. Please figure shipping times when placing your order. Next day, 2nd day or 3rd day shipping is also available.

## EXPOSTAR MAKES ORDERING EASY

Whether you're an old hand at working with trade show displays, or this is the first time you've even thought about it, ExpoStar makes ordering easy.

Your time is valuable, so look over the material in this guide carefully. It will help you as we move through the selection and design process, helping you be better informed in every decision you make along the way.

This guide is designed to make the selection process simple by grouping by size. Custom configurations of standard designs are available which make your choices limitless.

### Working with our Authorized Dealers

ExpoStar maintains a network of authorized dealers all across the country. This gives you excellent, at-your-fingertips service as you select the ExpoStar display system that best meets your needs and design the graphics that will ultimately tell your story.

To locate an authorized dealer nearest you, call 1-800-553-4445 or visit the ExpoStar web site at [www.expostar.com](http://www.expostar.com) and click on *Dealer Search*. Our web site also offers a wide variety of images, configurations, information and downloads to help you choose the display best suited to the needs of your next tradeshow experience.

All ExpoStar Displays are built by skilled craftsmen using only the finest display materials available. All materials and workmanship are guaranteed against defects for five years from the original date of purchase.

**PANEL SPECIFICATIONS**

**HOW TO USE THIS GUIDE**

Displays by ExpoStar offer you maximum flexibility. Each display in this guide features several versions of that system most often chosen by our customers. In most cases, that display or a slightly altered version of that system will fit your needs. However, because of the component-based concept of all ExpoStar displays, you have complete flexibility to create any kind, style or size of display you need. Just ask your authorized dealer to help you decide which ExpoStar solution best suits your tradeshow needs.

**ABOUT OUR GRAPHICS SERVICES**

As well as specializing in top-quality display kits and accessories, ExpoStar offers a fully staffed design department to assist you with your graphic needs. We gladly provide quotes for graphic services and materials for your display.

Our design staff has a wide range of capabilities including:

- n Assisting you in designing your display using your existing promotional materials.
- n Creating high-end computer generated graphics from photographs, illustrations and text, such as our large MegaMural Graphic designs.
- n Creating header graphics and reproducing logos for corporate identity.
- n Mounting and laminating photographs and artwork.
- n Producing signage and text panels for your display panels in vinyl or large format color printers.

Call for more information about our services. ExpoStar offers a turnkey approach to portable displays.

*The following size specifications define ExpoStar's basic and Arch-Top display panels (see next section— Displays).*

*ExpoStar also provides customized components, like columns, curve panels, towers, bridges and counters. Combine these components with our basic panels to increase the visual impact of your display.*

**BASIC PANELS**

ExpoStar's standard displays are based on a uniform size panel. Using these panels as building blocks, we can construct any configuration you need for your display.

**Single Panel**  
22" x 44", 4.5 lbs.

**Double Panel**  
44" x 44", 9 lbs.

**3-Panel**  
68" x 44", 13.5 lbs.

**4-Panel**  
90" x 44", 18 lbs.

**5-Panel**  
114" x 44"  
23 lbs.

**6-Panel**  
136" x 44"  
27 lbs.

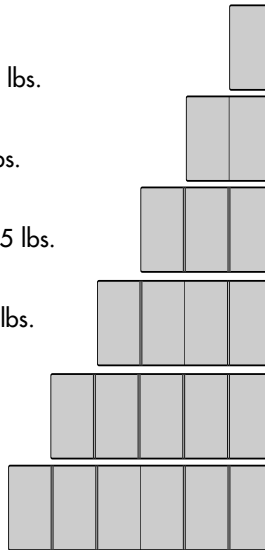

**ARCH-TOP PANELS**

All standard Arch-Top displays have a 2" accent stripe and header stripe on front side, solid color on back. Stripes are optional on back.

The following chart is provided to assist in placement and location of graphics.

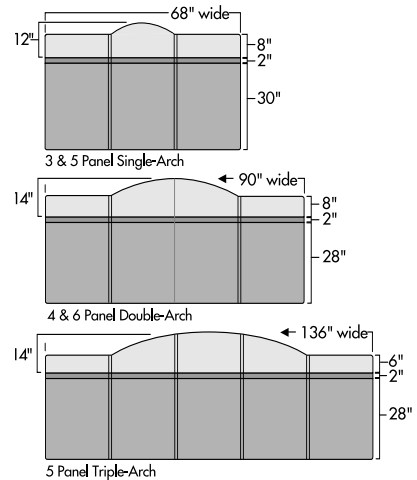

**For example:**

**A 5-Panel Tabletop Display**

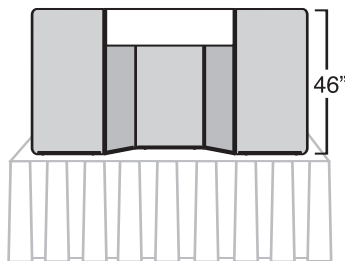

Single panel height 46"

**A 10-Panel Freestanding Display**

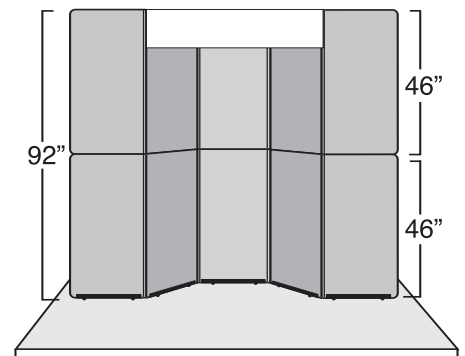

Stacked panel height 92"

Prices and specifications subject to change without notice

# TABLETOP DISPLAYS

## ABOUT OUR TABLETOPS

- n ExpoStar offers a variety of tabletop styles and sizes. All are light weight, versatile, set up quickly and ship in one case.
- n Bases can be added to tabletops to create a freestanding display.
- n ExpoStar introduces the new Rollaflex design featuring ExpoStar's patented rollable columns with rollable center panel.

\* The Standard Fabric price includes fabric covering front and back of display. The Fabric Upgrade listing indicates Front Runner® or Prelude® fabric upgrade on front and standard fabric on back. For fabric upgrade on back, add \$5 per panel.

\* Palladian Arch-top display shape and silhouette are protected by trademark #'s 2068109, 2048424, 2048423, 2048441.

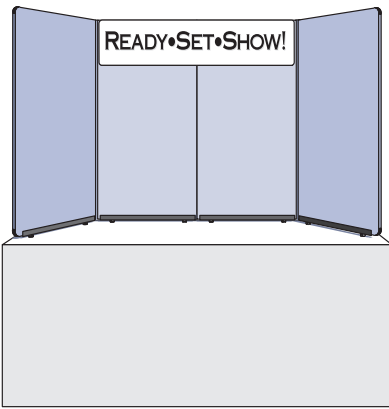

**RSS•4T - Ready-Set-Show**  
10"x44" radius header, one carton, 30lbs.  
\$595

### RSS•6MS - Mid-Size Tabletop

Our Mid-Size tabletop comes with 18" wide panels. This 6-panel display with backlit header is ideal for an 8' table. Includes light bar and corrugated case. Ship wt. 35lbs.  
\$695



### EPT•04A2 - 4-Panel Tabletop Palladian

This 4 panel shown on a 6' table. Add base and columns to create 10' Monticello Freestanding Display.  
\$795



\*Optional Padded Cordura Bag \$150

### Palladian

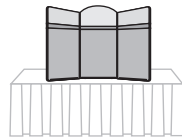

**EPT•03A1 3-Panel Tabletop**  
Clear arched header, one carton, 25 lbs.  
\$595

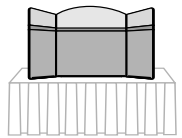

**EPT•04A2 4-Panel Tabletop**  
Clear arched header, one carton, 30 lbs.  
\$795

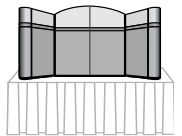

**EPT•04A2C 4-Panel Tabletop•Curve**  
Clear arched header, one carton, 30 lbs.  
\$995

## STANDARD PALLADIAN STRIPE SPECIFICATIONS

All Palladian Arch-Top Displays feature Palladian Arch-Top header stripe and 2" accent stripe on front, solid color on back. Stripes on back of the display are optional.

Additional striping is optional. Custom striping is also available. Standard Fabric, Tempo or Premier may be combined with Upgrade Fabric, Fronrunner or Prelude, for contrasting fabric textures.

### Ready-Set-Show

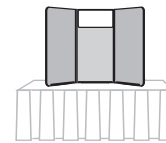

**RSS•3MT 3-Panel Mini-Tabletop**  
8"x 18" radius header, 18"x36" panesl, 25lbs.  
\$295

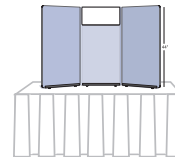

**RSS•3T 3-Panel Tabletop**  
10"x 22" radius header, one carton, 25 lbs.  
\$495

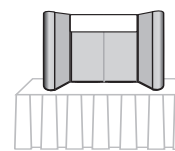

**RSS•4TC 4-Panel Tabletop•Curve**  
10"x 44" radius header, one carton, 35 lbs.  
\$795

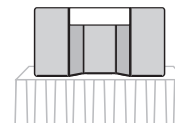

**RSS•5T 5-Panel Tabletop**  
12"x 44" backlit header, one carton, one light bar, 37 lbs.  
\$895

# TABLETOP DISPLAYS



**EPMT-03A1 - Mini Palladian\***  
Clear arched header, one carton, 25lbs.  
**\$495**

## ABOUT MINI-TABLETOPS

- Mini-Tabletops are ideal for recruiters, sales reps and presentations.
- Panel sizes 18" x 36".  
Entire tabletop packs into case 20" x 36" x 4".
- Total weight with case is 20lbs.
- Also available as 5-panel or 6-panel tabletops.



**RSS4MT- Mini Ready•Set•Show\***  
8"x36" radius header, one carton, 30lbs.  
**\$395**

\*Optional Padded Cordura Bag \$100

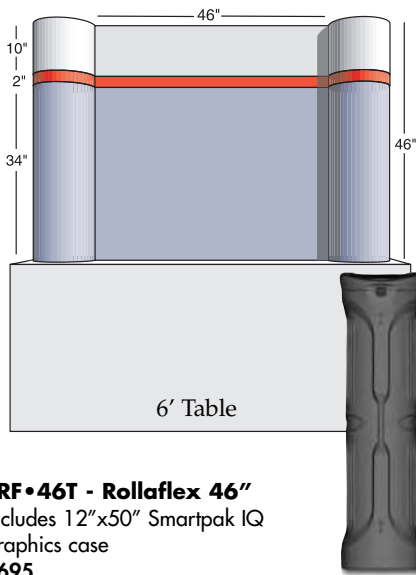

**ERF•46T - Rollaflex 46"**  
Includes 12"x50" Smartpak IQ graphics case  
**\$695**



## ABOUT ROLLAFLEX TABLETOPS

- n Rollaflex design features ExpoStar's patented rollable columns with rollable center panel.
- n Entire unit fits in 12" x 38" or 50" Smartpak Graphics Case.
- n Rollaflex can be covered with fabric, flexible marble laminate or large format mural graphics.

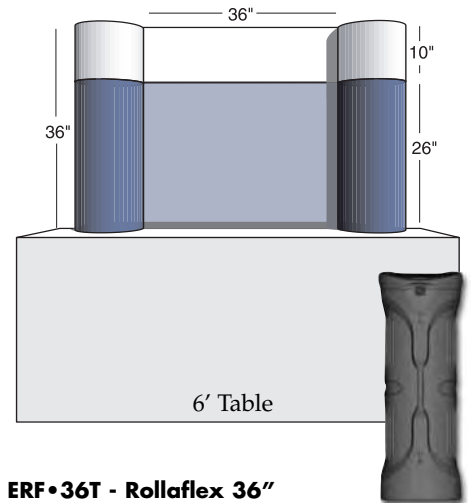

**ERF•36T - Rollaflex 36"**  
Includes 12"x38" Smartpak IQ graphics case  
**\$595**

Optional 75w Halogen Spotlights \$125 each

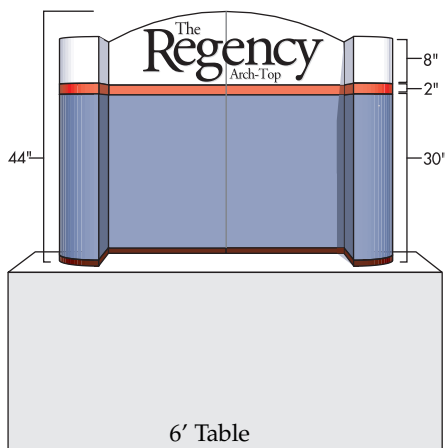

**ERT•44A2 - Regency Arch-Top**  
**\$895**

## Regency

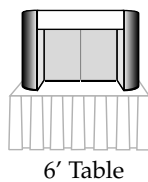

**ERT•44**  
**2-Panel Tabletop**  
44" backwall, 12" x 44" backlit header and light bar, one carton, 35 lbs.  
**\$895 Standard Fabric**  
**\$955 Fabric Upgrade\***

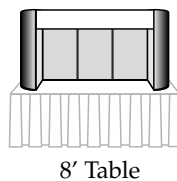

**ERT•66**  
**3-Panel Tabletop**  
66" backwall, 12" x 69" backlit header and light bar, one carton, 40 lbs.  
**\$935 Standard Fabric**  
**\$995 Fabric Upgrade\***

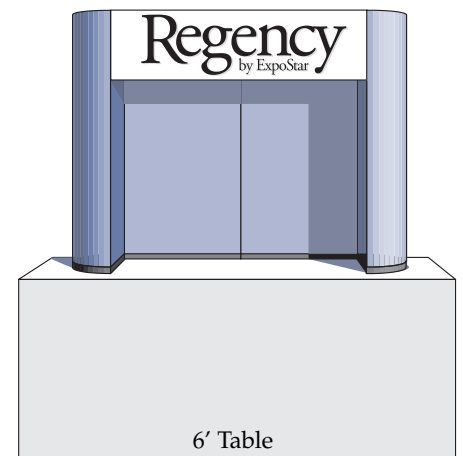

**ERT•44T - Regency**  
**\$895**

# TENFOOT FREESTANDING DISPLAYS

## ABOUT OUR TENFOOT DISPLAYS!

- n All displays include blank header.
- n The required number of corrugated shipping cartons are provided with each display kit. Ship weight includes corrugated cartons.
- n Create 20' or larger displays by joining any combination of free-standing units with fabric-covered joiner strips.
- n Standard striping includes inlaid header stripe and 2" accent stripe on front. Stripes may be added as desired.

\* The Standard Fabric price includes fabric covering front and back of display. The Fabric Upgrade listing indicates Front Runner® or Prelude® fabric upgrade on front and standard fabric on back. For fabric upgrade on

### Palladian

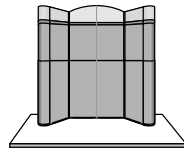

**EPF-08A2C**  
**8-Panel with Curves**  
 Clear header, two cartons,  
 35 lbs. each.  
**\$1895**

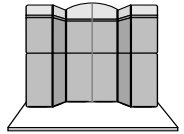

**EPF-12A2**  
**12-Panel Freestanding**  
 Clear header, two cases,  
 42 lbs. each.  
**\$2195**

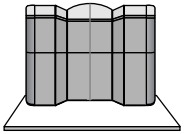

**EPF-12A2C**  
**12-Panel with Curves**  
 Clear header, curved end  
 panels, two cartons, 47 lbs.  
 each.  
**\$2595**

## STANDARD PALLADIAN STRIPE SPECIFICATIONS

All Palladian Arch-Top Displays feature Palladian Arch-Top header stripe and a 2" accent stripe on front side, solid color on back. Stripes on the back side of the display are optional.

Stripes may be added or deleted as desired. Custom striping is also available. Standard Fabric, Tempo or Premier may be combined with Upgrade Fabric, Frontrunner or Prelude, for contrasting fabric textures.

### EPF-1 2A2C - 10' Palladian

This display features inlaid fabric stripe. Lighting is two 75 watt halogen spotlights.  
**\$2595**

### Renaissance

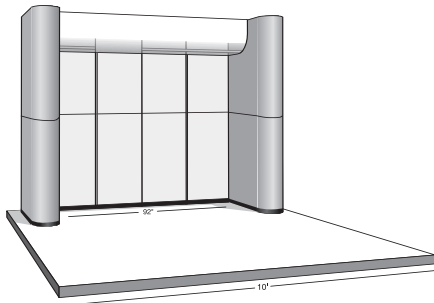

**RSB-8 - 10' Renaissance**  
 Display 8-panel folding backwall.  
 Includes new convex backlit header and 2  
 light bars. Ships in three shipping cartons.  
**\$2695**  
**\$520 - 1 molded case, 1 column case**



### Ready-Set-Show

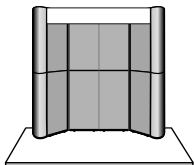

**RSS-8C**  
**8-Panel Freestanding**  
 12" x 69" backlit header,  
 light bar, curved end caps,  
 two cartons, 35 lbs. each.  
**\$1775**  
**\$1435 without curves**

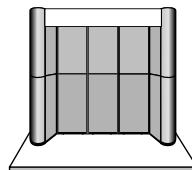

**RSS-10C**  
**10-Panel Freestanding**  
 12" x 80" backlit header,  
 two light bars, curved  
 end panels, two cartons,  
 37 lbs. each.  
**\$2295**

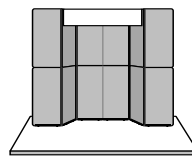

**RSS-12**  
**12-Panel Freestanding**  
 12" x 60" backlit header,  
 light bar, two cartons,  
 40 lbs. each.  
**\$1995**

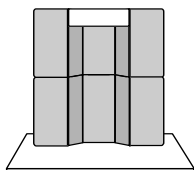

**RSS-10**  
**10-Panel Freestanding**  
 12" x 44" backlit header,  
 light bar, two cartons,  
 33 lbs. each.  
**\$1695**  
 (add \$380 for curves)

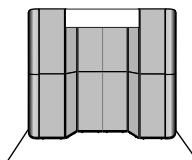

**RSS-12C**  
**12-Panel Freestanding**  
 12" x 60" backlit header,  
 light bar, curves, two  
 cartons, 45 lbs. each.  
**\$2495**



### RSS-12C - Ready-Set-Show

This 12 panel features a 12"x60" backlit header, 3 bulb light bar and curved end caps. Shown with optional 10" accent stripe and matching 4-panel counter.

**\$2735\$855 ED4-40 Counter (as shown)**

# TEN FOOT FREESTANDING DISPLAYS

## Monticello



The center section, top or bottom, of our ten foot Monticello can easily be used as a four panel tabletop.

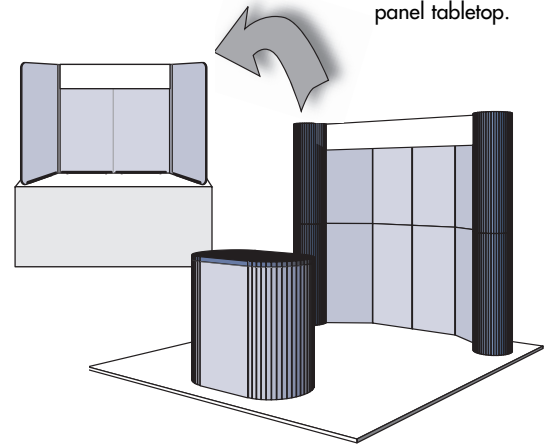

### EMC•8C-BL - 10' Monticello

Includes 80"x12" backlit header. Ships in one HDSC-W molded shipping case and one 12"x50" Smartpak shipping case included. Shown with optional ECCM-40 counter.

**\$2495 Standard Fabric**



### MC•8C2-BL - 10' Monticello with 80" Backlit Header

Includes two columns, 3 bulb light bar, 2" base accent stripe and header stripe.

**\$2885**

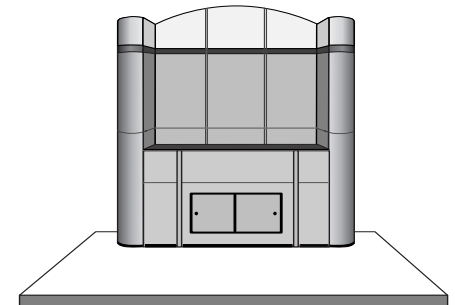

### ERF•6A3C - Regency 8' Arch-Top with Recessed Counter.

Shown with arch-top header with inlaid fabric stripes and 40" high counter with sliding doors. Ships in three cartons, 50 lbs. each.

**\$2895**

### MC•8C2-A2 - 10' Arch-Top Monticello

Includes two columns, 2" accent and header stripe on front side, solid color on back. Includes clear Lexan® header. Ships in two cartons. Lighting shown is two 200 watt wall washers.

50 lbs each.  
**\$2595** includes molded cases  
**\$145** Wall Washer (each)



### MC-8C2-BL Monticello

This display features an inlaid fabric base accent stripe as well as header stripe, backlit header and counter. Graphics are created on large format digital printers.

**\$2885**

**\$1065** optional counter with stripes

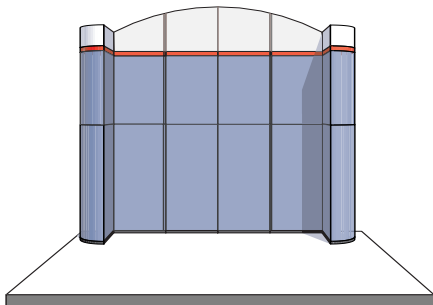

### ERF•8A4 - Regency 10' Arch-Top Display

Shown with arch-top header with inlaid fabric stripes. Ships in three cartons, 50lbs. each. Fits in 10' booth.

**\$2745**

## Regency

### ERF•6

#### 6-Panel Freestanding

12" x 70" backlit header, light bar, two cartons, 45 lbs.

**\$2270**

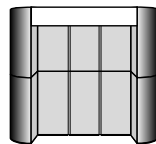

### ERF•6RC

#### 6-Panel Counter

12" x 70" backlit header, light bar, 20" x 69" counter, three cartons, 45 lbs. each.

**\$2795**

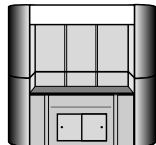

### ERF•8

#### 8-Panel Freestanding

12" x 92" backlit header, two light bars, two cartons, 50 lbs. each.

**\$2695**

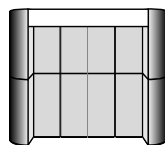

### ERF•8RC

#### 8-Panel Counter

12" x 92" backlit header, 40" tall counter, two light bars, three cartons, 50 lbs. each.

**\$3290**

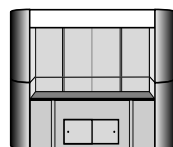

# TWENTY FOOT FREESTANDING DISPLAYS

## ABOUT OUR TWENTY FOOT DISPLAYS!

- n The Monticello displays feature ExpoStar's unique patented rollable columns and are available with backlit headers, or our trademark Arch-Top® header.
- n Our Regency displays include our lightweight rollable end caps and backlit headers with lightbars where applicable.
- n Renaissance displays with their lightweight rollable end columns use our patent-pending hub design.

\* The Standard Fabric price includes fabric covering front and back of display. The Fabric Upgrade listing indicates Front Runner® or Prelude® fabric upgrade on front and standard fabric on back. For fabric upgrade on back, add \$10 per panel.

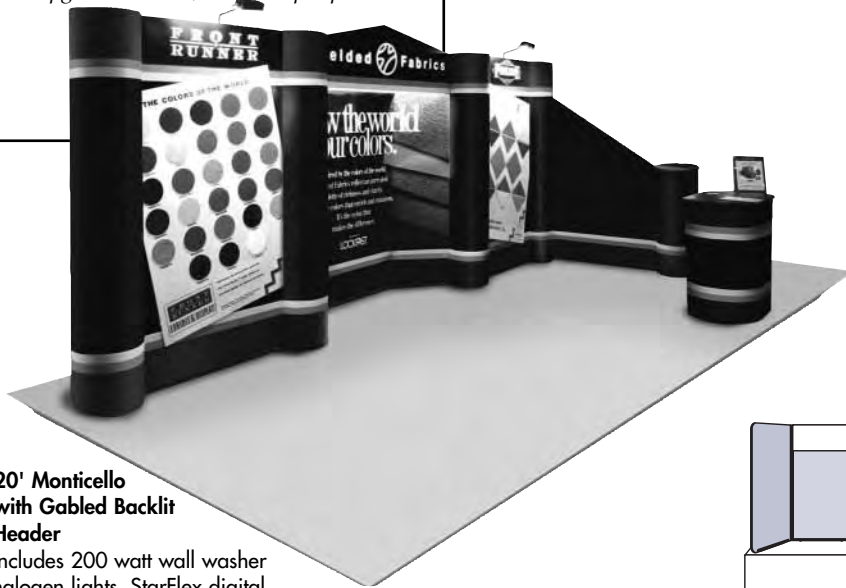

### 20' Monticello with Gabled Backlit Header

Includes 200 watt wall washer halogen lights. StarFlex digital graphics are used to create special larger-than-life swatch cards with fabric attached.

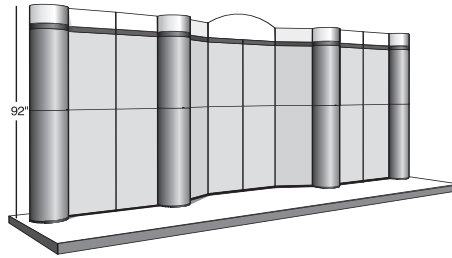

### MC•16C4-A2 - 20' Monticello

Includes four columns, 2" accent stripe and header stripe front side, solid color on back. Clear Lexan® header. Ships in three cartons, 50 lbs. each. Can also be used as 8-panel freestanding or 4-panel tabletop.

**\$4695**

Optional features:

**\$240** Striping on back

**\$680** Marble columns (\$85 per column section)

**\$815** Molded case upgrade (requires only two molded case and one round case)

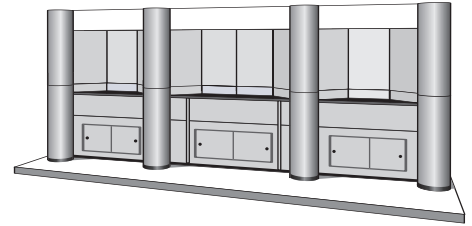

### MC•20C4-BL - 20' Monticello with Backlit Headers and Counters

Includes four columns, four 3-bulb lightbars, 2" accent stripe and header stripe front side, solid color on back. Three translucent Lexan® headers. Ships in seven cartons, 50 lbs.

**\$7595**

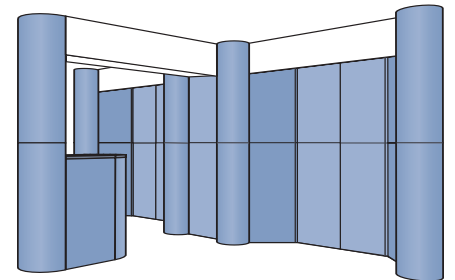

### 20' Monticello with Backlit Headers, tower and bridge and counter.

Includes four columns, six 3-bulb lightbars, Four translucent Lexan® headers. Ships in six cartons.

**\$6995**

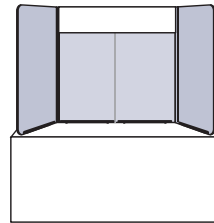

Our 20' Monticello easily transforms from 20' to 10' or Tabletop display, depending on the need or amount of space available to you.

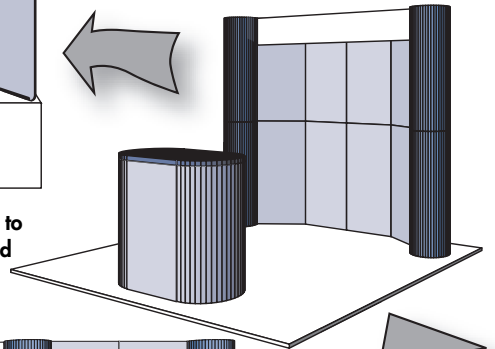

### EMC•16C - 20' Monticello

Includes eight patented rollable column sections. Features 12"x 80" backlit header with 3-bulb 100w lightbar.

Ships in two HDSC-W molded shipping cases and one 16"x50" Smartpak Graphics Case. Shown with optional ECCM-40 curved counters. Counters ship in one case each.

**\$4995**

**\$825 ea. ECCM-40 counters**

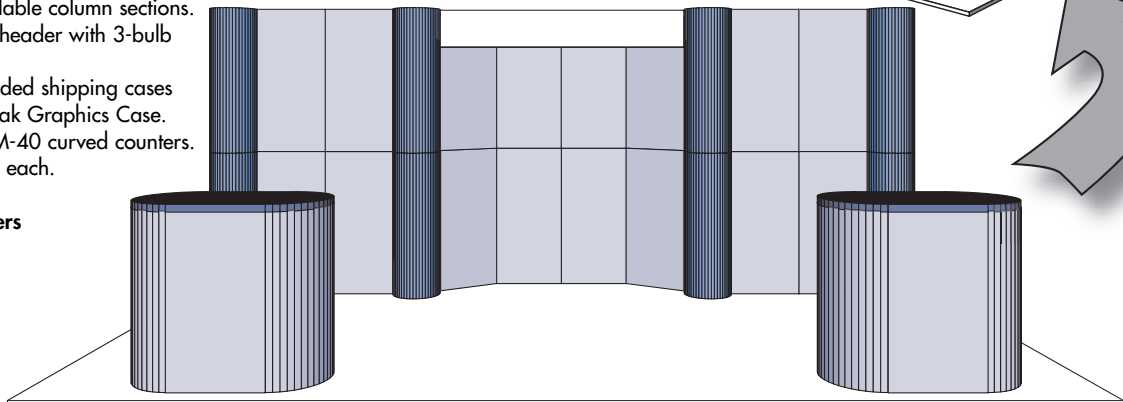

ExpoStar Arch-Top Displays,  
Trademark #'s 2068109,  
2048424, 2048423, 2048441

# TWENTY FOOT FREESTANDING DISPLAYS

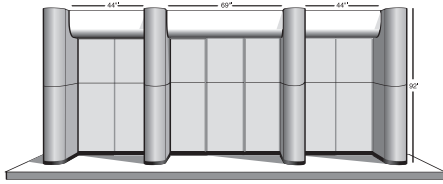

## RSB•14 - Renaissance 20' Display

Includes new convex backlit headers and 4 lightbars. Ships in five shipping cartons.

**\$4995**

**\$1040 - 2 molded cases, 2 column cases**

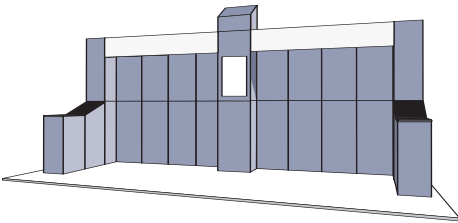

## 20' Independence with Tower and Bridge

Features patented ExpoStar square columns and angled side counters. Backlit headers are 12"x92" with 22" wide center tower. Opening can be added to tower for AV monitor or backlit graphic. Ships in six cartons.

**\$8325**

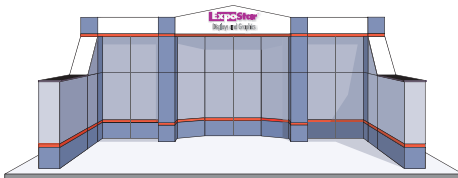

## 20' Independence with Gabled Header

With 44" tall counters create a wraparound 20' in-line booth. Features a gabled backlit header. Pictured with optional accent stripes on base. Ships in six cases.

**\$7795**

**\$480 Stripes on back**

**\$5805 Without counters**

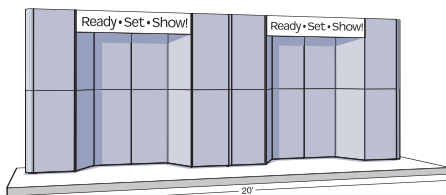

## RSS•24C - 20' Ready-Set-Show

Two 12 panel displays. 60"x12" backlit headers, 3 bulb lightbar, 2 joiner strips, curves. Ships in four cartons.

**\$3995**



## 20' Renaissance with backlit headers

Includes MegaMural graphics, rollable curved headers and rollable columns. Symbol and map on face of the tower are backlit graphics.

## RFD•20TB - 20' Regency

Ideal for large mural graphics and features a tower and bridge with 92"x12" backlit headers for added visibility. Can be used separately as a 10" display as well. Packs into six cases.

**\$6995**

**\$980 Accent Stripes**

**\$1295 Tower, Bridge**

**\$725 Counter**

**\$195 Tower striping and counter**

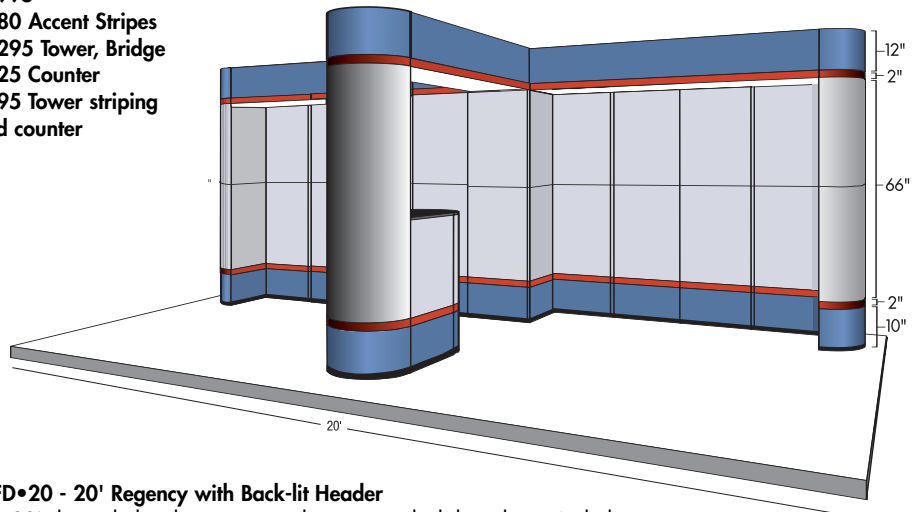

## RFD•20 - 20' Regency with Back-lit Header

The 20' shown below has a recessed counter with sliding doors. Includes two 12"x92" backlit headers with lightbars and optional counter. Ships in seven corrugated shipping cases included.

**\$5395**

Can be used separately as 10' freestanding display.

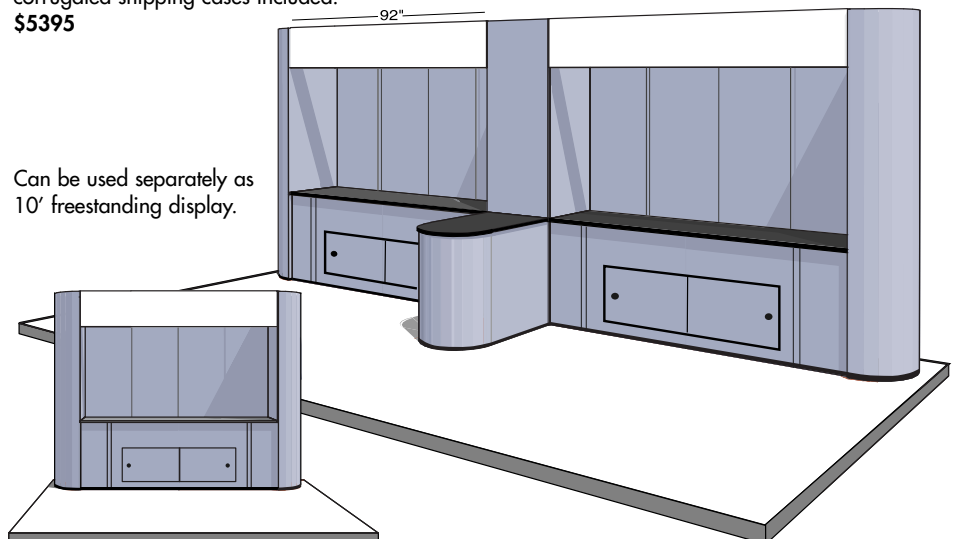

## ABOUT OUR CUSTOM DISPLAYS!

If your marketing plan includes making a big splash at your next tradeshow but the budget does not include a truck-load of custom display components, then ExpoStar's Island series may be your best solution. Towers and bridges with backlit graphics will burn through the competition. ExpoStar islands will make your next show a winner.

ExpoStar custom displays have a solid look usually associated with more expensive and much less portable displays.

## Versatile Configurations



This 20'x20' Portable Island Display includes backlit rotating tower header and backlit bridge headers. Metallic gold vinyl applied to the rollable columns enhance the "cutaway" effect of the large format closeups. Two color ExpoStar inlaid fabric stripes accent and add texture.



### MC•20/20-BL Island Display, Monticello with Tower and Bridge Headers

This island configuration features a backlit tower, WrapSurround backlit bridge and column graphics. Includes 8 patented rollable columns, packs into 5 Smartpak cases and 6 molded cases.

**\$19,795**

Unit includes 2 ECCM-40 Counters, Striping and fabric upgrades, WrapSurround backlit Headers, 8-14"x84" Headers with Soffits, 4-24"x36" Backlit Posters on Columns, 4-22"x36" Backlit Tower Headers, 4-16"x36" Backlit Column Sections. Backlit Header and Column Graphics

**\$9,500**

5-16"x50" Molded Smartpak Cases

**\$1,125**

6-HDSC-W Molded Cases

**\$1,770**

For more information on ExpoStar Displays and Graphics and the wide range of possibilities that exist for your next tradeshow experience, visit our web site,



### Creative Custom Columns

Custom columns may be created in a variety of shapes. This twenty foot freestanding display features backlit columns for an even more dramatic effect.



The "wooden posts" on this twenty foot freestanding display attract valuable attention and are, in reality, MegaMural graphics wrapped around ExpoStar rollable columns.



### Architectural Design Motifs

The column flutes are computer graphics, output on large format color printers, on this twenty foot display and the countour cut header graphic takes on the appearance of a tiled overhang.



This 20' in-line display appears to be as solid as brick and mortar but in reality is a lightweight portable that easily transports in molded cases with wheels.

# CUSTOM DISPLAYS

## FEATURED DISPLAYS

### 20' x 20' Independence Island

This island configuration features four square towers with backlit "V" bridge headers attached to the 12' tall center towers. Lightboxes can be added to towers to highlight graphics. Ships in twelve cartons.

Tower and Bridges	\$13,570
Counters (\$795 each)	\$3,180
Total price as shown with cartons:	\$16,750
with molded cases:	\$20,290

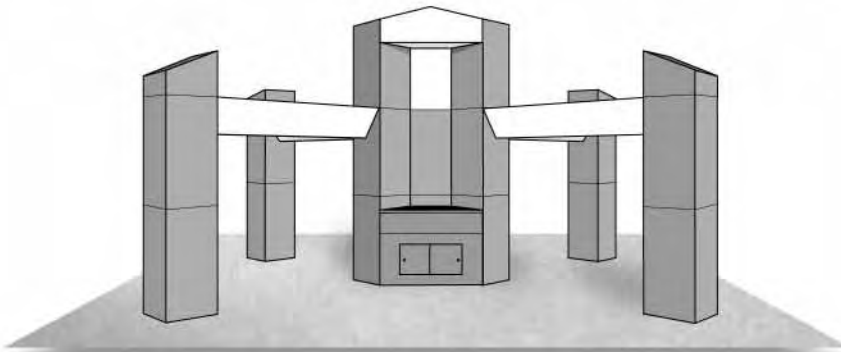

### 20'x20' Tower with Regency Counters

This 20' x 20' configuration uses Monticello columns to create a striking four sided tower configuration with attached peninsula counters. Regency counters with backlit headers round out and help create an appealing and efficient selling environment.

as shown in 14 cartons	\$15,200
with molded cases	\$18,955

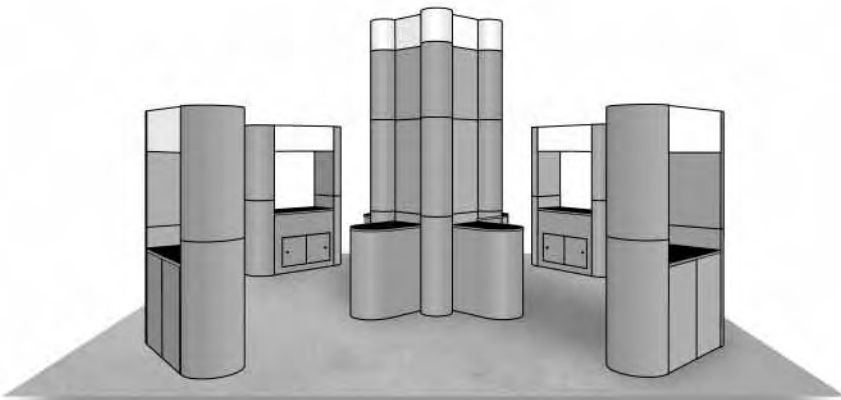

### 20'x20' Regency Island

This island configuration features a tower with attached curved podiums, backlit bridge headers, and Regency columns with attached peninsula counters, as well as corner step counters.

As shown in 13 cartons	\$14,610
with molded cases	\$18,185

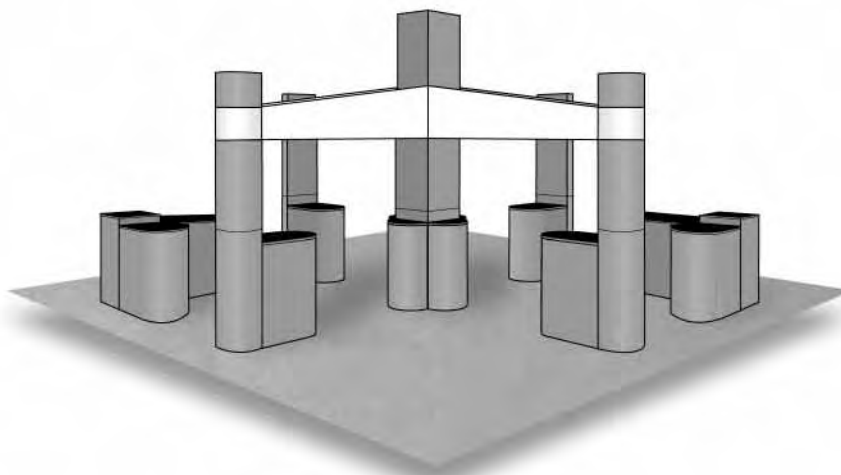

# SMARTPAK IQ® MOLDED SHIPPING CASES

## ABOUT SMARTPAK IQ®

- n Double reinforced lid features unique 2-way hinge and Franzen security lock.
- n Nylon carry strap with adjustable shoulder pad attaches quickly and securely with black powder coated steel hardware.
- n High performance in-line skate wheels with sealed bearings reduce drag.
- n Running gear is protected by cus-

## Protect Your Assets.



Cutaway, sculpted and contoured sections are precision engineered to add strength and reduce overall bulk. Blow-molded to allow the use of a higher density, more durable polyethylene than conventional rotational molded cases.

# SmartPak®

## GRAPHICS CASES

Don't let the sleek lines and glamorous blue pearlescent finish fool you. IQ is strong and secure even under the most demanding field conditions. The Smartpak IQ case is blow-molded to allow the use of a higher density polyethylene than conventional roto-molded graphics cases.

When you ship with Smartpak you can rest assured that your precious cargo will arrive safe and sound!

Superior durability, along with new easy handling features like in-line skate wheels, quick-flip two-way lid, and balance compensation pull bar makes Smartpak IQ the most innovative large format graphics case you've ever seen.

### Smartpak IQ™ Molded Shipping Cases

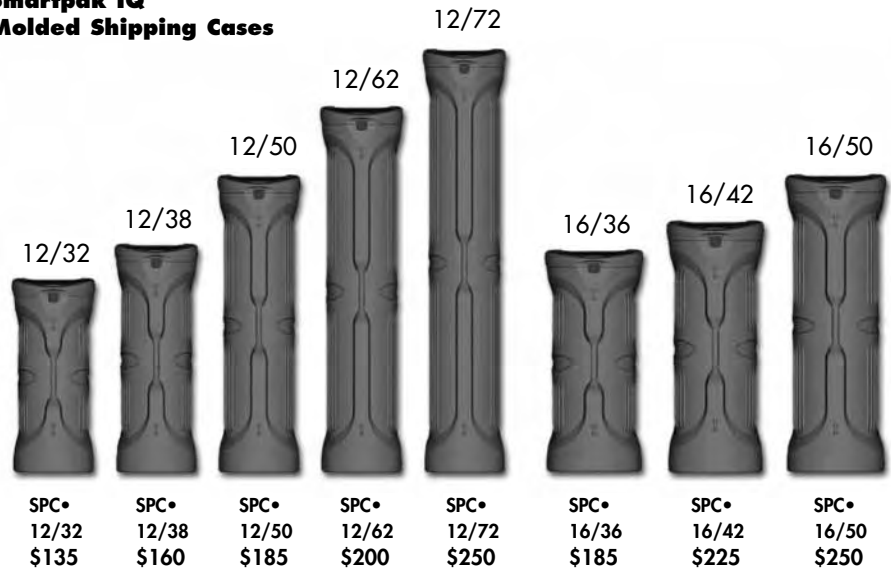

The original Smartpak gray case is still available and can be purchased in most of the sizes mentioned above.



## SHIPPING CASES

### Cordura® Shipping Cases

#### CSC•47 - Cordura® Nylon Case

Gray with blue shoulder straps, handwrap. Holds 46" tall tabletop displays. \$150

#### CSC•37 Cordura® Nylon Case

This smaller case is perfect for sales reps for easy carrying. For mini-sized tabletop displays. Size 20" x 36" x 4" \$100



CSC•46

### Heavy-Duty Molded Shipping Cases

#### HDSC•W Large Case with wheels

24"x 50"x 6"\*, 22 lbs.\* \$295

#### HDSC•W42 Small Case with wheels

24"x 42"x 7"\*, 18 lbs.\* \$245

*Smaller case ideal for podiums or small tabletop kits less than 40" tall. (black only).*

*\*Adds 12 lbs. to kit weight per case.*



HDSC•W

## FABRICS

PM•63 Premier® Fabric (no upcharge)

PR•55 Prelude® Fabric  
\$5 per panel per side

FR•55 Front Runner® Fabric  
\$5 per panel per side

### Cut Yardage

TF•60 Tempo® Fabric 60" wide \$21 per yard  
(Standard Fabric)

FR•55 Front Runner® 63" wide \$27 per yard

PM•63 Premier® 63" wide \$25 per yard

PR•55 Prelude 63" wide \$27 per yard

Durable transport and storage cases protect your display investment show after show. Available in a wide variety of types and sizes to fit your requirements.



## PANEL ACCESSORIES

### Foot Channel

FC•22 - With bumper

\$5 each

### Stacking Guides

SG•18

\$2.50 each

### Joiner Strips

JS•H \$35

JS•90° \$35

JS•180° \$45

JS•360° \$50

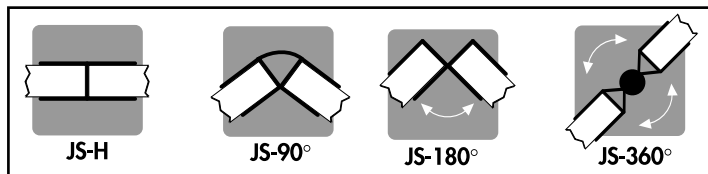

JS-H

JS-90°

JS-180°

JS-360°

### ABOUT JOINER STRIPS

Fabric-covered joiner strips allow panels to be joined in a variety of ways. Two joiner strips are required for freestanding displays.

## LIGHTS

*Fixture prices include bulb(s) and 14' three-wire cordset.*

#### WW•200

#### 200W Wall Washer

10" arm with slip-on base  
2lbs. \$145

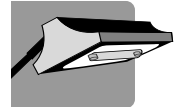

#### HL•75

#### Wire Form Halogen Fixture

75w par 16 halogen bulb,  
10" arm with slip-on base  
2 lbs. \$125



#### BLB•100

#### 3-Bulb Light Bar

150w halogen bulbs., 2 lbs.  
\$95

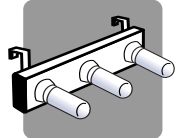

### Replacement Bulbs

LB•75H - 75w par 16 Halogen Bulb

\$10.00

HLB-150 100w Halogen Bulb

\$10.00

RHB•35 - 35w bulb for HSL•35 lightbar

\$7.50

Bulbs. for WW•200

200w halogen bulb \$15

## ABOUT CUSTOM STRIPING

n Custom striping adds bold graphic lines or a subtle design element to your display.

n To calculate cost for adding stripes, simply count the number of fabric stripes (or seams) and the number of panels and/or curves to be striped. Use the chart below for assistance.

n For *Curved Podium*, *Curved Desk* or *Curved Tower* add \$25 per stripe per seam. For Monticello columns add

### NUMBER OF SEAMS OR STRIPES

	PANELS WITH STRIPES							
	1	2	3	4	5	6	7	8
1	\$15	\$30	\$45	\$60	\$75	\$90	\$105	\$120
2	\$30	\$60	\$90	\$120	\$150	\$180	\$210	\$240
3	\$45	\$90	\$135	\$180	\$225	\$270	\$315	\$360
4	\$60	\$120	\$180	\$240	\$300	\$360	\$420	\$480
5	\$75	\$150	\$225	\$300	\$375	\$450	\$525	\$600

## PODIUMS, COUNTERS

### ABOUT PODIUMS

All Podiums, including Tables, Desks and Pedestals, fold flat and ship in one carton (shipping carton included in kit price).

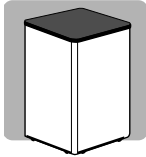

**EPS•40**  
3-Panel Podium - 40"  
2' x 2' counter top,  
25 lbs. **\$495**

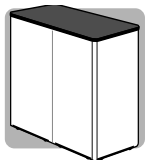

**ED4•30**  
4-Panel Desk - 30"  
2' x 4' top, 42 lbs. **\$715**

**EC4•40**  
4-Panel Counter - 40"  
2' x 4' top, 45 lbs. **\$735**

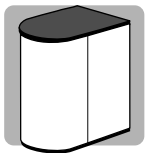

**EPC•30**  
Peninsula Counter - 30"  
24" x 30" top, 40 lbs. **\$695**

**EPC•40**  
Peninsula Counter - 40"  
24" x 30" top, 44 lbs. **\$725**

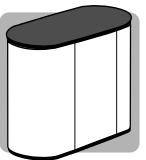

**ECDM•30**  
Curved Desk - 30"  
24" x 46" top, front panel,  
shelf. 40 lbs. **\$795**

**ECCM•40**  
Curved Counter - 40"  
40" high with 24" x 46"  
top, 45 lbs. **\$825**

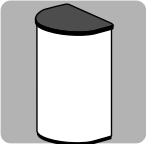

**ECP•40**  
Curved Podium - 40"  
12" x 24" tabletop,  
28 lbs. **\$395**

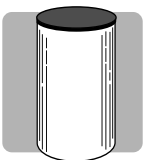

**RPB•30**  
**RPB•40**  
Circular Pedestal  
24" diameter top, 30 lbs.  
**30" high \$375**  
**40" high \$395**

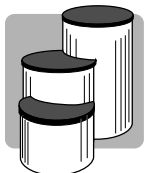

**RBSP•3**  
Circular Step Pedestals  
24" diameter tops,  
40", 30" & 20", 55 lbs.  
**\$895**

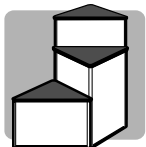

**TSP•3**  
Triangular Step Tables  
40", 30" & 20" high,  
55 lbs. **\$975**

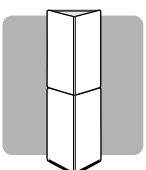

**TST•6**  
Triangle Tower  
Two 3-panel stacking  
units, 88" high, 38 lbs.  
Use as two 3-panel  
tabletop displays.  
**\$830**

### DOOR ASSEMBLIES

Optional door panels for use with tables, counters and podiums. Keylocks for doors are available at \$25 each.

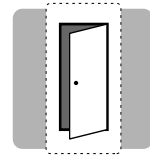

**HD•16/24**  
**Hinged Door (door only)**  
16" x 24" door. Maximum  
size 18" x 36". Fits curved  
podiums, or add to any  
desk or counter panel.  
**\$95**

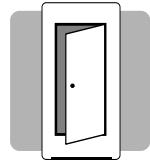

**HDA•22/40**  
**Single Panel Door Assem-  
bly**  
16" x 24" door fits *Curved  
Counter* or *3-Panel Podium*.  
**HDA•22/30** fits 30"  
*Curved Desk*. 8 lbs.  
**\$225**

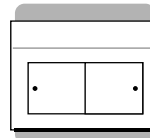

**SDA•30/44**  
**4-Panel Desk Door**  
16" x 36" sliding door fits  
*4-Panel Desk*, 30" high.  
12 lbs.  
**\$275**

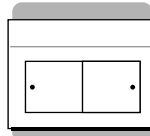

**CSD•40/44**  
**4-Panel Counter Door**  
16" x 36" sliding door fits  
*4-Panel Counter*, 40" high.  
15 lbs.  
**\$295**

### RECESSED COUNTERS

Fits freestanding units to provide counter and cabinet space for display and storage.

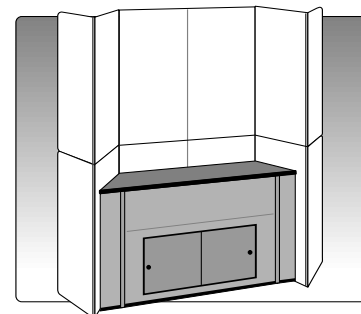

**RCA•60/30**  
**Recessed Counter 30"H**  
60" x 18" laminated hinged top and sliding  
door. Folds flat for shipping. Fits 8 and 12-  
panel freestanding displays.  
44 lbs.  
**\$495**

**RCA•60/40**  
**Recessed Counter 40"H**  
Taller version of above counter. 48 lbs.  
**\$555**

Note: Custom size counters also available.

## HEADERS

### ABOUT HEADERS

- n **Backlit Headers**  
Rollable, one-piece translucent Lexan® attached to aluminum frames with magnetic strips.
- n **Palladian Arch Headers**  
Clear Lexan® attached with Velcro.
- n **Radius Headers**  
White Sintra® with radius corners attached with Velcro.
- n **Continuous Wrap Headers**  
Flexible Lexan® or vinyl attached

### Backlit Headers

**BLH•12/44** 12" x 44" Backlit Header  
Fits RSS•3T, 5T, 10F. 2 lbs. **\$95**

**BLH•12/60** 12" x 60" Backlit Header  
Fits RSS•4T, 6T, 8F, 12F. 3 lbs. **\$135**

**BLH•12/69** 12" x 69" Backlit Header  
Fits ERF•6, 6TK. 3 lbs. **\$145**

**BLH•12/80**  
12" x 80" Backlit Header  
Fits RSS•10C. 3 lbs. **\$175**

**BLH•12/92**  
12" x 92" Backlit Header  
Fits ERF•8, 8TK, 8SK. 4 lbs. **\$195**  
*Lightbar not included with backlit headers.*



### Palladian Arch Headers

**PH•12/22**  
12" x 22" Single Arch Header  
1.5 lbs. **\$25**

**PH•14/44**  
14" x 44" Double Arch  
Header 2 lbs. **\$35**

**PH•14/69**  
14" x 69" Rollable Triple Arch Header  
1 lb. (.020 clear Lexan film) **\$45**

**PH•10/18** Mini Single Arch Header  
10" x 18" 1.5 lbs. **\$20**

**PH•12/36** Mini Double Arch Header  
12" x 36" 2 lbs. **\$30**



### Radius Headers

**RH•10/22**  
10" x 20" Radius Header  
2 lbs. **\$25**

**RH•10/44**  
10" x 44" Radius Header  
4 lbs. **\$35**

**RH•8/18**  
8" x 18" Mini Radius Header 1.5 lbs. **\$20**

**RH•8/36**  
8" x 36" Mini Radius Header 2 lbs. **\$30**

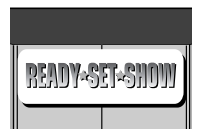

For more information on ExpoStar Displays and Graphics visit our web site,

## CUSTOMIZED COMPONENTS

The following components coupled with our basic display panels maximize visual impact and create a more expansive custom look.

### TOWER & BRIDGE

ETB-84BLH

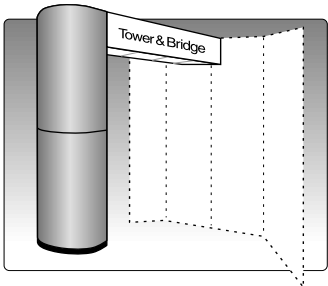

Backlit bridge header attaches to tower to create double-sided lighted header for corporate identity. Tower may also be used separately as two 46" podiums by adding curved podium tops. Includes two light bars. One carton, 55 lbs.

\$1295

### SOFFIT PANELS

Translucent Lexan<sup>®</sup> soffit panels are available for all backlit headers. Simply unroll, attach to the header with magnets and to the display with Velcro<sup>®</sup> to provide a diffuser for the light bar. \$1 per inch length of header

### LIGHT BOXES

CLB•16/30

Collapsible Light Box

Includes framed cutout (18" x 30" max), 3-bulb light bar.

\$250

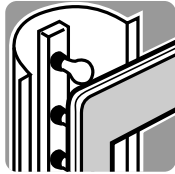

### PANEL WINDOW

PCO•16/30 Panel Window

Panel openings can be custom cut for video monitors, recessed shelving, etc. or any specifications no larger than 18" x 30".

\$75

### CURVE PANELS

Customize your display by adding ExpoStar's unique 360° curved end caps or columns. Simply roll and lock into place for each assembly. Order right and left pair for tabletop, and two pair (right and left) for free-standing displays. Patent pending.

CP•44 Curved End Cap

44"H, lays flat for shipping \$95 each\*  
\*Add \$15 per seam for striping.

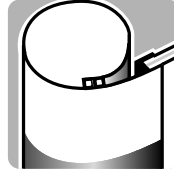

EMC•46 Rollable One-Piece Columns

15" diameter 360° column to use as endcaps See Monticello pages 10-11  
\$195 each\*  
\*Add \$25 per seam for striping.

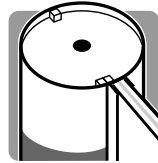

ESC•46 Square One-Piece Columns

12" column \$225 each\*  
\*Add \$25 per seam for striping

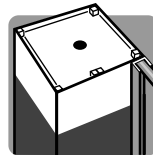

ERC•46 Renaissance Column

\$250 each  
\*Add \$25 per seam for striping.

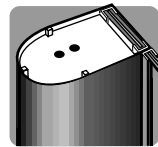

ERS•46 Regency Column

\$265 each  
\*Add \$25 per seam for striping.

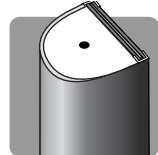

## TABLE ACCESSORIES

Available in a wide range of colors and fabrics, all skirts include Velcro<sup>®</sup> top banding. Skirts can be custom imprinted with your company name or logo. 14' table skirts wrap all sides of 6' table and 3 sides of 8' table 21' table skirts wrap all sides of 8' table.



Banjo Skirt

SBJ•14 - 29" X 14' Skirt \$105

SBJ•21 - 29" X 21' Skirt \$180

PolyKnit Skirt

SBK•14 - 29" X 14' Skirt \$60

SBK•21 - 29" X 21' Skirt \$90

PolySateen<sup>®</sup> Skirt

SBS•14 - 29" X 14' Skirt \$50

SBS•21 - 29" X 21' Skirt \$90

PolyTwill<sup>®</sup> Skirt

PolyTwill is Shirred, includes table clips

SPT•14 - 29" X 14' Skirt \$162

SPT•21 - 29" X 21' Skirt \$200

PolyTwill<sup>®</sup> Table Throw Covers

SPC•6 One-piece cover fits 6' table \$125

SPC•8 One-piece cover fits 8' table \$145

Vinyl Table Covering VTC•30

30" wide, various colors \$1.45 per yard

Table Skirt Clips TCV•3

Fits all table styles \$2.50 each

Skirt Hangers HSK•1

Helps keep skirts wrinkle-free \$8.50 each

## SLATWALL

SWP•18/30 Slat-Wall Panels

Fabric covered slatwall panels can be recessed into display panels up to 18" wide x 30" high. \$175



## LITERATURE HOLDERS

FLH•5

5" Flat Folding Holder  
4 oz. \$13

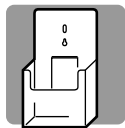

FLH•9

9" Flat Folding Holder  
11 oz. \$18

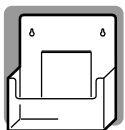

ABH•4

Business Card Holder  
\$5

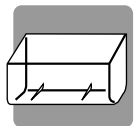

PPS•20

6" X 20" Product Shelf  
flat folding, 2 lbs. \$45

PPS•40

6" X 40" Product Shelf  
flat folding, 4 lbs. \$75

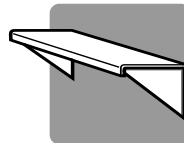

PLS•20

Plastic Literature Shelf  
11.5" x 20", 2 lbs. \$45

PLS•40

Plastic Literature Shelf  
11.5" x 40", 4 lbs. \$75

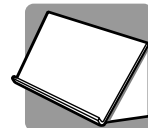

## SHELVES

Shelves with Standards

Shelves with standards can be attached to most panels. Available with 6", 8" and 10" shelves. \$195 per section with three shelves.

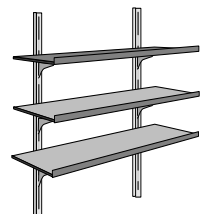

# TYPES OF GRAPHICS

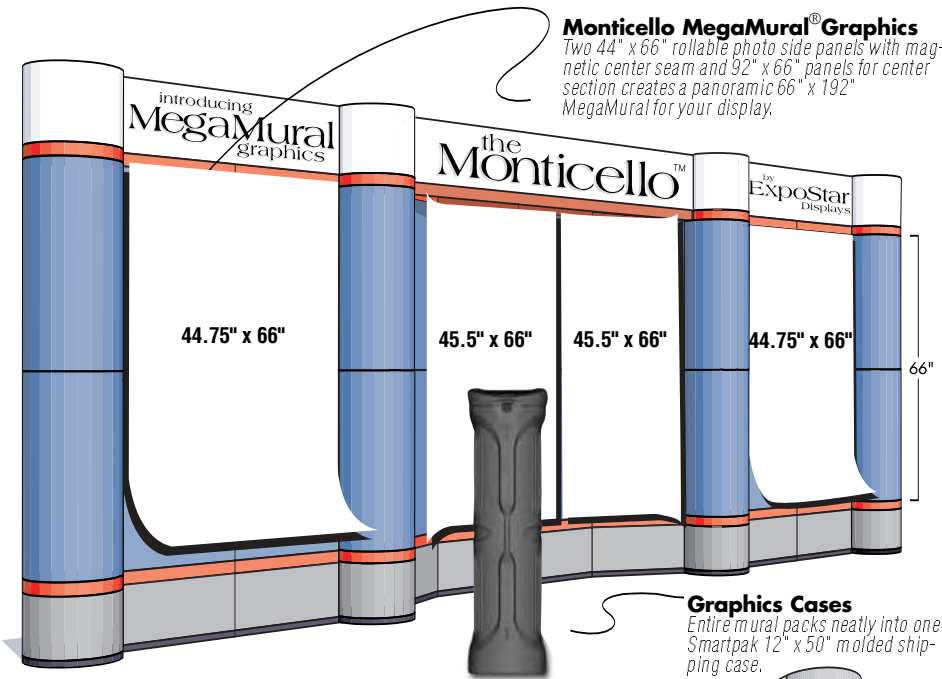

## Pop-up Graphics

The Standard Size for each Starlite™ pop-up panel is 26.5" X 88". ExpoStar also produces graphics for all other sizes of Pop-up display units. Pop-up displays may be full graphic as shown at right, or with fabric panels and a continuous header as shown below.

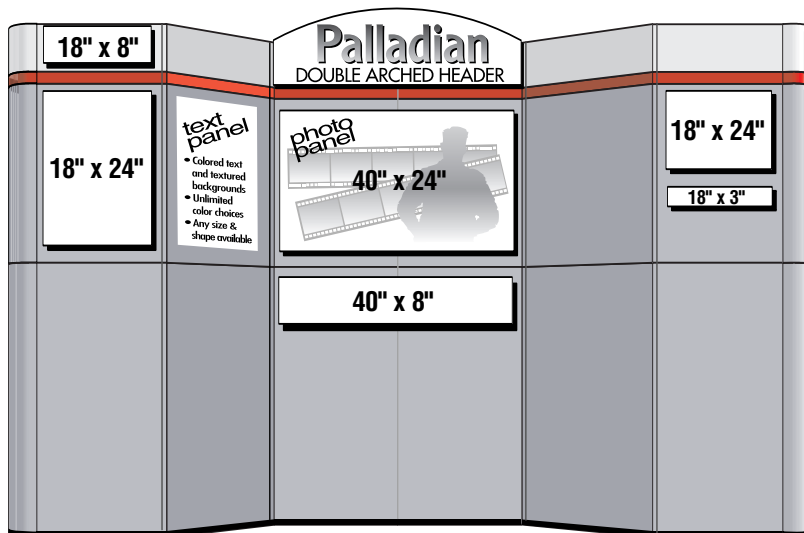
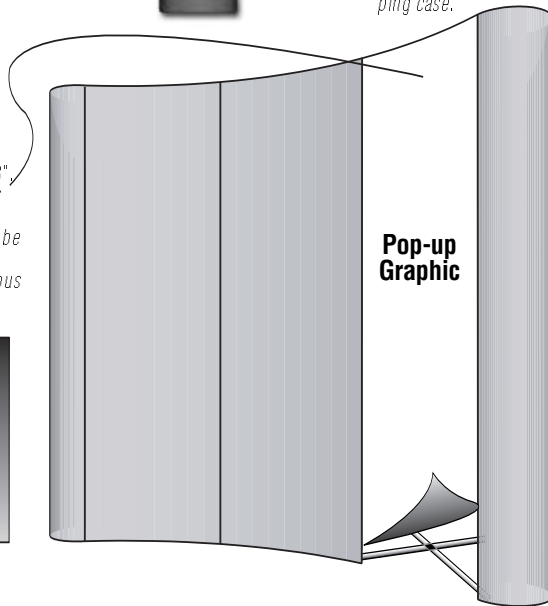
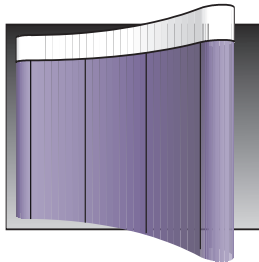

## MEGAMURAL™ GRAPHICS

With this incredible computer process, any combination of photographs, backgrounds, logos and text can be combined, retouched, enhanced and printed in mural sizes. Transform your display walls into show stopping vistas with ExpoStar MegaMural graphics.

## PHOTO PANELS

Large photos make dynamic display signage. Photos can be reproduced directly from your transparencies or enhanced through color correction and retouching. Captions can be applied directly to photo or added with separate text strip signs.

## EXPOGRAPHICS

From charts and graphs to location maps, there is no limit to the informative and eye-catching original color graphics that ExpoStar can create. Let us design excitement and interest into your next presentation.

## HEADERS

The center or main sign on a display, often incorporating a company logo or name, is very important to your display's impact. A wide range of brilliant colors and backgrounds are available. Photos and other graphics can also be incorporated into the header.

## BACKLIT SIGNAGE

Most signage and photo panels can be prepared on translucent backgrounds for use with lightboxes. Backlit headers, available for many displays, add a bright new dimension to your message.

## TEXT STRIPS & PANELS

Signs with brief text can be created in a variety of ways- from single color text on clear plastic, to a rainbow assortment of colors and background textures.

## VINYL SIGNS

Durable, economical, vibrant. Vinyl signage adds an attractive accent to any graphics package.

**EXPOGO!**  
ExpoStar®-Prezenta®-ArchiForm®

# GRAPHICS SPECIFICATIONS

## Media Accepted

CD Rom Disks,  
DVD Disks  
Files may be FTP'd to ExpoStar  
(call for user name and password).  
Files up to 5mb may be emailed to  
[graphics@expoStar.com](mailto:graphics@expoStar.com)

## Format Requirements

For output from your disk, supply  
native document at 100%, 50% or  
25% of actual size in one of the fol-  
lowing applications:

### For Digital Graphics:

Adobe Illustrator (preferred)  
(vector art with fonts outlined)  
Quark XPress  
Adobe InDesign  
Freehand  
Adobe Photoshop (photos)

### For Vinyl Graphics

Adobe Illustrator  
(vector art with fonts outlined)

*Photoshop images must scale to a mini-  
mum 100dpi, maximum 150dpi, at fin-  
ished size.*

Please remember to outline fonts or  
supply fonts when necessary. Placed  
files can be EPS, JPEG or TIFF For-  
mats, RGB mode.

## Color Matching

The ExpoStar Graphics Studio is  
equipped with the latest technology  
in digital printers available in the  
graphics and display industry.  
ExpoStar cannot guarantee exact  
color matching due to the nature of  
screen values that interpret color and  
other limitations inherent in this  
type of color printing equipment. We  
will do our best to match colors as  
specified, with the highest possible  
level of accuracy but **we must have a  
specific PMS color to match to or a  
hard copy proof of the desired  
result.** Reprinted Archived files can-  
not be depended on for color match-  
ing.

Color prints that require exact color  
matching from one to the other must  
be batch printed.

## Resolution

All Photoshop or other bitmapped digital images must be supplied at a res-  
olution of 100-150 dpi at the finished size of the graphic being produced.

## Resolution Formula

Choose smallest dimension of original image and smallest dimension of final  
size.

Final Size ÷ Original Size x 100 dpi = Minimum Resolution

Final Size ÷ Original Size x 150 dpi = Maximum Resolution

Example: Output final image at 44" x 55"

1) 4" x 5" original 44" ÷ 4" = 11      11 x 75 dpi = 1100 dpi = minimum

2) 2.5" x 3.5" original 44" ÷ 2.5" = 18      18 x 75 dpi = 1800 dpi = minimum

Note: If the image is not to be used full frame, make sure that cropped  
dimension is used to determine resolution.

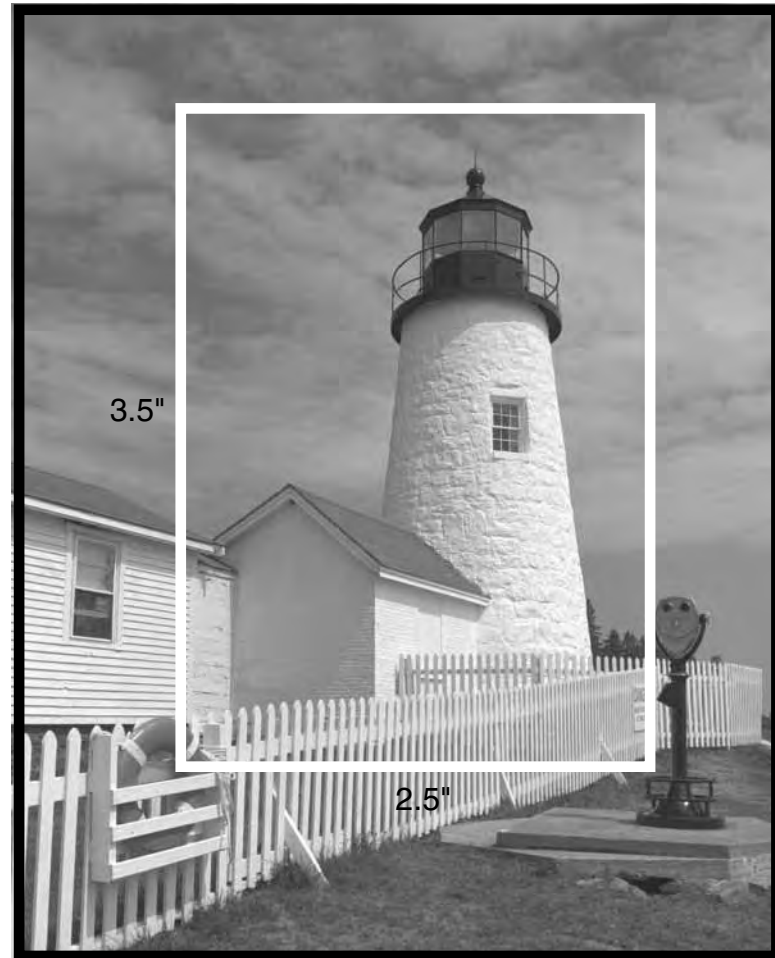

4"

## Hardware and Software

ExpoStar's inhouse designers and creative staff are equipped with the latest  
technology in high-end computer systems and large format printers.

# Partial Client Listing

AARP  
AFLAC  
Air Force Dept. of Investigations  
American Institute of Bldg. Design  
American Red Cross  
Anchor Continental  
AT&T Fitel  
Atlanta Paralympics  
Bald Head Island  
BASF  
Billy Graham Evangelistic Assoc.  
British Broadcasting Corporation  
Blue Cross/Blue Shield  
Budget Rent-A-Car  
Carolco Film Studios  
Central Carolina Bank  
CIA  
CIBA  
Circuit City  
City of Los Angeles  
City of West Hollywood  
Classic Games Incorporated  
Corning  
Curious Kids Museum  
Dixie Stampede  
Dornier Medical Systems  
Duke University Medical Center  
Dun & Bradstreet  
DuPont  
East Carolina University  
Egleston Children's Hospital  
Emory University  
Entertainment Weekly  
Exide Corporation  
Ezell Trucking Company  
Floor Coverings International  
Florida State University  
Foss Manufacturing  
Fredrickson Motor Express  
Fujitsemo, USA

General Electric  
General Services Administration  
Georgia Forestry Commission  
Georgia Pacific Corporation  
Georgia Tech  
Girl Scout Council  
Gourmet Magazine  
Grand Strand General Hospital  
Great Smokies Hotel Assoc.  
Gregory Poole  
GTE  
Hampton Inn  
HBO & Company  
Hilton Las Vegas  
Hiltons of the Carolinas  
Historic Naval Ships Association  
Hoechst-Celanese  
Hospice  
ILCO Uican Corporation  
Instrument Society of America  
Integrated Technology Corp.  
John Hancock Financial Services  
Johnson & Johnson  
K-Mart  
Kaiser Permanente  
Kent State University  
Kodak Chemical  
Konica Manufacturing  
Lifestar Memorial Medical Center  
Los Alamos National Laboratory  
Lucent Technologies  
Luxor Casino  
March of Dimes  
Marriott Orlando World Center

Martin Marietta  
MCI  
Med Plus Medical Services  
Mendocino National Forest  
Milliken  
Naegele Outdoor Advertising  
National Fire & Rescue  
National Institute of Health  
National Park Service  
Nat. Press Photographers Assoc.  
National Scuba Program  
National Small Business Council  
Naval Subase - Bangor Maine  
NC Aquarium  
NC Assoc.for Biomedical Research  
NC Assoc.for the Gifted & Talented  
NC Department of Commerce  
NC Department of Crime Control  
NC Employment Security Comm.  
NC Public Transportation Assoc.  
NC State Bureau of Investigation  
NC State Port Authority  
NC State University  
Nickelodeon  
Norrell Health Care  
Novartis  
Occidental Chemical Corporation  
Ohio University  
Oklahoma State University  
Omni Richmond Hotel  
Operation Baby Buckle  
Overnite Trucking Company  
OxyChem  
Pfizer Chemical

Philadelphia Civic Center  
Pittsburgh Paint Industries / PPG  
Pizza Hut, Inc.  
Reeds Jewelers  
Research Triangle Institute  
Rockwell International  
Rutgers University  
Sacred Heart Catholic Church  
Saguaro National Monument  
Salvation Army  
SAS Institute, Inc.  
SC Firefighters Association  
Screen Gems Productions  
Sega  
Six Flags over Georgia  
SmithKline Beecham  
St. Joseph's Hospital  
Subway Headquarters  
The Pentagon  
This End Up Furniture Company  
University of Florida  
University of Maine  
University of Missouri  
University of North Carolina  
University of the Virgin Islands  
UPS  
USAir  
US Army  
US Army Corps of Engineers  
US Fish & Wildlife  
US Forest Service  
US Geological Survey  
US Marine Corps  
USS Battleship North Carolina  
Washington Golf Monthly  
Wieland Corporation  
Xiox Corporation  
Young Indy Productions  
Youth Service of America  
Zion Canyon Theatre Marketing



**Sales: 423-952-0770**  
**DisplayHQ.com**  
**sales@DisplayHQ.com**

Your Authorized Expostar Dealer